

# CHAPTER 36

## Learning Objectives

- Types of Single-phase Motors
- Single-phase Induction Motor
- Double-field Revolving Theory
- Making Single-phase Induction Motor Self-starting
- Equivalent Circuit of Single-phase Induction Motor without Core Loss
- Equivalent Circuit With Core Loss
- Types of Capacitors Start Motors
- Capacitor Start-and-Run Motor
- Shaded-pole Single-phase Motor
- Repulsion Type Motors
- Repulsion Motor
- Repulsion Principle
- Compensated Repulsion Motor
- Repulsion-start Induction-Run Motor
- Repulsion Induction Motor
- A.C. Series Motors
- Universal Motor
- Speed control of Universal Motors
- Reluctance Motor
- Hysteresis Motor

## SINGLE-PHASE MOTORS



Single phase motor

### 36.1. Types of Single-Phase Motors

Such motors, which are designed to operate from a single-phase supply, are manufactured in a large number of types to perform a wide variety of useful services in home, offices, factories, workshops and in business establishments etc. Small motors, particularly in the fractional kilo watt sizes are better known than any other. In fact, most of the new products of the manufacturers of space vehicles, aircrafts, business machines and power tools etc. have been possible due to the advances made in the design of fractional-kilowatt motors. Since the performance requirements of the various applications differ so widely, the motor-manufacturing industry has developed many different types of such motors, each being designed to meet specific demands.



Split-phase motor. Switch mechanism disconnects start winding when motor reached three-fourths of rated speed

Single-phase motors may be classified as under, depending on their construction and method of starting :

1. **Induction Motors** (split-phase, capacitor and shaded-pole etc.)
2. **Repulsion Motors** (sometime called Inductive-Series Motors)
3. **A.C. Series Motor**
4. **Un-excited Synchronous Motors**

### 36.2. Single-phase Induction Motor

Constructionally, this motor is, more or less, similar to a polyphase induction motor, except that (i) its stator is provided with a single-phase winding and (ii) a centrifugal switch is used in some types of motors, in order to cut out a winding, used only for starting purposes. It has distributed stator winding and a squirrel-cage rotor. When fed from a single-phase supply, its stator winding produces a flux (or field) which is only *alternating i.e.* one which alternates along one space axis only. It is not a synchronously revolving (or rotating) flux, as in the case of a two- or a three-phase stator winding, fed from a 2- or 3-phase supply. Now, an alternating or pulsating flux acting on a *stationary* squirrel-cage rotor cannot produce rotation (only a revolving flux can). That is why a single-phase motor is *not self-starting*.



Single-phase induction motor

However, if the rotor of such a machine is given an initial start by hand (or small motor) or otherwise, *in either* direction, then immediately a torque arises and the motor accelerates to its final speed (unless the applied torque is too high).

This peculiar behaviour of the motor has been explained in two ways : (i) by two -field or double-field revolving theory and (ii) by cross-field theory. Only the first theory will be discussed briefly.

### 36.3. Double-field Revolving Theory

This theory makes use of the idea that an alternating uni-axial quantity can be represented by two oppositely-rotating vectors of half magnitude. Accordingly, an *alternating* sinusoidal flux can be

represented by two **revolving** fluxes, each equal to half the value of the alternating flux and each rotating synchronously ( $N_s = 120f/P$ ) in opposite direction\*.

As shown in Fig. 36.1 (a), let the alternating flux have a maximum value of  $\Phi_m$ . Its component fluxes A and B will each be equal to  $\Phi_m/2$  revolving in anticlockwise and clockwise directions respectively.

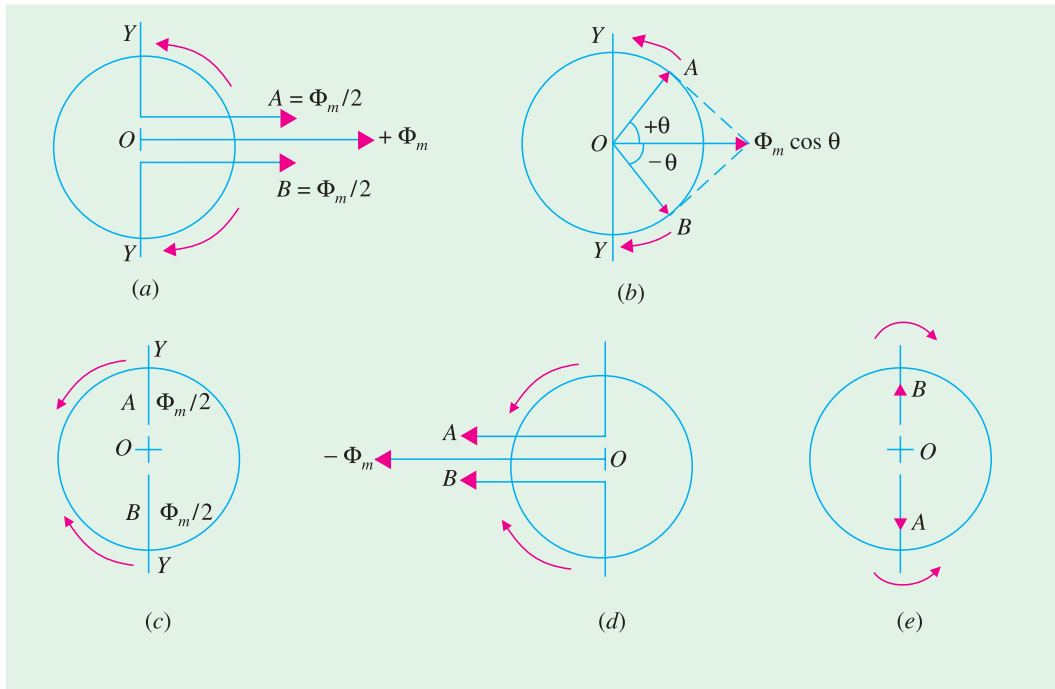

Fig. 36.1

After some time, when A and B would have rotated through angle  $+\theta$  and  $-\theta$ , as in Fig. 36.1 (b), the resultant flux would be

$$= 2 \times \frac{\Phi_m}{2} \cos \frac{2\theta}{2} = \Phi_m \cos \theta$$

After a quarter cycle of rotation, fluxes A and B will be oppositely-directed as shown in Fig. 36.1 (c) so that the resultant flux would be zero.

After half a cycle, fluxes A and B will have a resultant of  $-2 \times \Phi_m/2 = -\Phi_m$ . After three-quarters of a cycle, again the resultant is

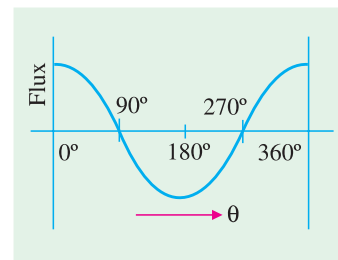

Fig. 36.2

\* For example, a flux given by  $\Phi = \Phi_m \cos 2\pi ft$  is equivalent to two fluxes revolving in opposite directions, each with a magnitude of  $1/2\Phi$  and an angular velocity of  $2\pi f$ . It may be noted that Euler's expressions for  $\cos \theta$  provides interesting justification for the decomposition of a pulsating flux. His expression is

$$\cos \theta = \frac{e^{j\theta} + e^{-j\theta}}{2}$$

The term  $e^{j\theta}$  represents a vector rotated clockwise through an angle  $\theta$  whereas  $e^{-j\theta}$  represents rotation in anticlockwise direction. Now, the above given flux can be expressed as

$$\Phi_m \cos 2\pi ft = \frac{\Phi_m}{2} (e^{j2\pi ft} + e^{-j2\pi ft})$$

The right-hand expression represents two oppositely-rotating vectors of half magnitude.

zero, as shown in Fig. 36.1 (e) and so on. If we plot the values of resultant flux against  $\theta$  between limits  $\theta = 0^\circ$  to  $\theta = 360^\circ$ , then a curve similar to the one shown in Fig. 36.2 is obtained. That is why an alternating flux can be looked upon as composed of two revolving fluxes, each of half the value and revolving synchronously in opposite directions.

It may be noted that if the slip of the rotor is  $s$  with respect to the forward rotating flux (*i.e.* one which rotates in the same direction as rotor) then its slip with respect to the backward rotating flux is  $(2 - s)^*$ .

Each of the two component fluxes, while revolving round the stator, cuts the rotor, induces an e.m.f. and this produces its own torque. Obviously, the two torques (called forward and backward torques) are oppositely-directed, so that the net or resultant torque is equal to their difference as shown in Fig. 36.3.

Now, power developed by a rotor is  $P_g = \left(\frac{1-s}{s}\right) I_2^2 R_2$

If  $N$  is the rotor r.p.s., then torque is given by  $T_g = \frac{1}{2\pi N} \cdot \left(\frac{1-s}{s}\right) I_2^2 R_2$

Now,  $N = N_s(1-s) \quad \therefore T_g = \frac{1}{2\pi N_s} \cdot \frac{I_2^2 R_2}{s} = k \cdot \frac{I_2^2 R_2}{s}$

Hence, the forward and backward torques are given by

$$T_f = K \frac{I_2^2 R_2}{s} \quad \text{and} \quad T_b = -K \cdot \frac{I_2^2 R_2}{(2-s)}$$

or  $T_f = \frac{I_2^2 R_2}{s} \text{ synch.watt} \quad \text{and} \quad T_b = -\frac{I_2^2 R_2}{(2-s)} \text{ synch.watt}$

Total torque  $T = T_f + T_b$

Fig. 36.3 shows both torques and the resultant torque for slips between zero and +2. At standstill,  $s = 1$  and  $(2 - s) = 1$ . Hence,  $T_f$  and  $T_b$  are numerically equal but, being oppositely directed, produce no resultant torque. That explains why there is no **start-ing** torque in a single-phase induction motor.

However, if the rotor is started somehow, say, in the clockwise direction, the clockwise torque starts increasing and, at the same time, the anticlockwise torque starts decreasing. Hence, there is a certain amount of net torque in the clockwise direction which accelerates the motor to full speed.

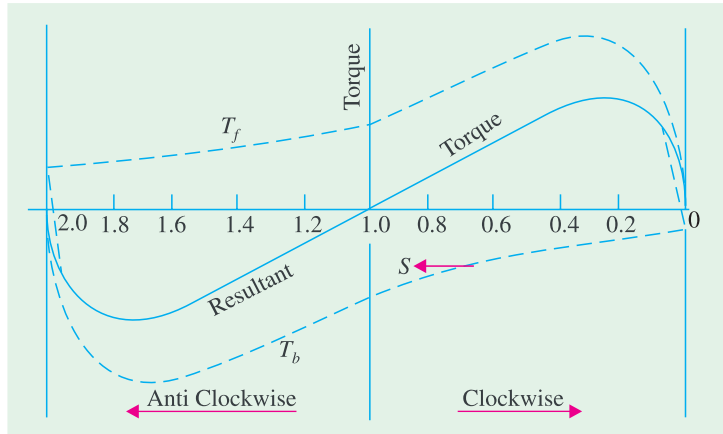

Fig. 36.3

\* It may be proved thus : If  $N$  is the r.p.m. of the rotor, then its slip with respect to forward rotating flux is

$$s = \frac{N_s - N}{N_s} = 1 - \frac{N}{N_s} \quad \text{or} \quad \frac{N}{N_s} = 1 - s$$

Keeping in mind the fact that the backward rotating flux rotates opposite to the rotor, the rotor slip with respect to this flux is

$$s_b = \frac{N_s - (-N)}{N_s} = 1 + \frac{N}{N_s} = 1 + (1 - s) = (2 - s)$$

### 36.4. Making Single-phase Induction Motor Self-starting

As discussed above, a single-phase induction motor is not self-starting. To overcome this drawback and make the motor self-starting, it is temporarily converted into a two-phase motor during starting period. For this purpose, the stator of a single-phase motor is provided with an extra winding, known as **starting** (or auxiliary) winding, in addition to the **main or running winding**. The two windings are spaced  $90^\circ$  electrically apart and are connected in *parallel* across the single-phase supply as shown in Fig. 36.4.

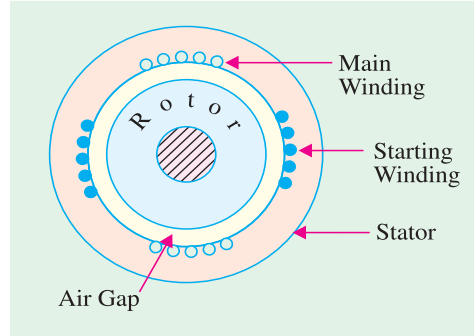

Fig. 36.4

It is so arranged that the phase-difference between the currents in the two stator windings is very large (ideal value being  $90^\circ$ ). Hence, the motor behaves like a two-phase motor. These two currents produce a revolving flux and hence make the motor self-starting.

There are many methods by which the necessary phase-difference between the two currents can be created.

(i) In *split-phase machine*, shown in Fig. 36.5 (a), the main winding has low resistance but high reactance whereas the starting winding has a high resistance, but low reactance. The resistance of the starting winding may be increased either by connecting a high resistance  $R$  in series with it or by choosing a high-resistance fine copper wire for winding purposes.



Single-phase motor.

Hence, as shown in Fig. 36.5 (b), the current  $I_s$  drawn by the starting winding lags behind the applied voltage  $V$  by a small angle whereas current  $I_m$  taken by the main winding lags behind  $V$  by a very large angle. Phase angle between  $I_s$  and  $I_m$  is made as large as possible because the starting torque of a split-phase motor is proportional to  $\sin \alpha$ . A centrifugal switch  $S$  is connected in series with the starting winding and is located inside the motor. Its function is to automatically disconnect the starting winding from the supply when the motor has reached 70 to 80 per cent of its full-load speed.

In the case of split-phase motors that are hermetically sealed in refrigeration units, instead of internally-mounted centrifugal switch, an electromagnetic type of relay is used. As shown in Fig. 36.6, the relay coil is connected in series with main winding and the pair of contacts which are normally open, is included in the starting winding.

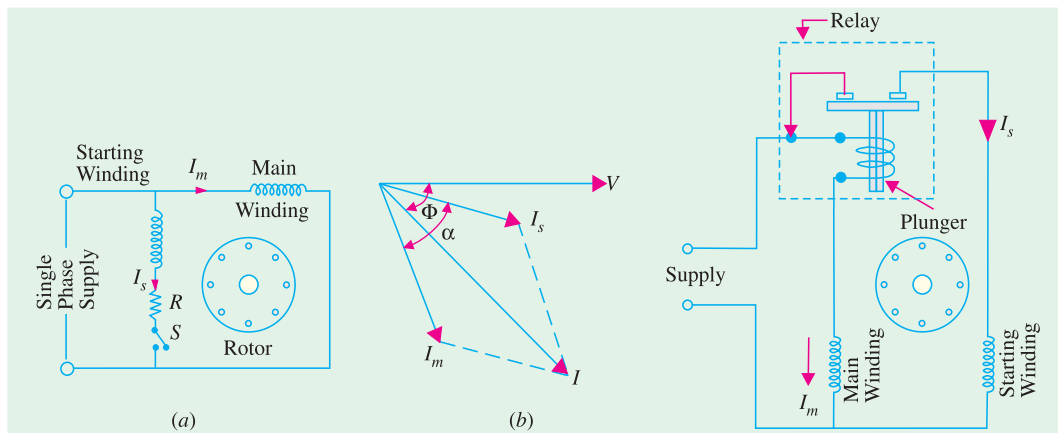

Fig. 36.5

Fig. 36.6

During starting period, when  $I_m$  is large, relay contacts close thereby allowing  $I_s$  to flow and the motor starts as usual. After motor speeds up to 75 per cent of full-load speed,  $I_m$  drops to a value that is low enough to cause the contacts to open.

A typical torque/speed characteristic of such a motor is shown in Fig. 36.7. As seen, the starting torque is 150 to 200 per cent of the full-load torque with a starting current of 6 to 8 times the full-load current. These motors are often used in preference to the costlier capacitor-start motors. Typical applications are : fans and blowers, centrifugal pumps and separators, washing machines, small machine tools, duplicating machines and domestic refrigerators and oil burners etc. Commonly available sizes range from 1/20 to 1/3 h.p. (40 to 250 W) with speeds ranging from 3,450 to 865 r.p.m.

As shown in Fig. 36.8, the direction of rotation of such motors can be reversed by reversing the connections of one of the two stator windings (not both). For this purpose, the four leads are brought outside the frame.

As seen from Fig. 36.9, the connections of the starting winding have been reversed.

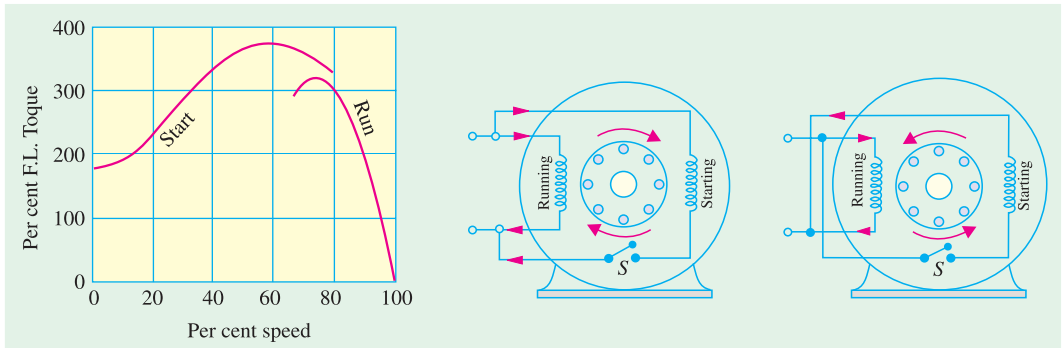

Fig. 36.7

Fig. 36.8

Fig. 36.9

The speed regulation of standard split-phase motors is nearly the same as of the 3-phase motors. Their speed varies about 2 to 5% between no load and full-load. For this reason such motors are usually regarded as practically constant-speed motors.

**Note.** Such motors are sometimes referred to as resistance-start split-phase induction motors in order to distinguish them from capacitor-start induction run and capacitor start-and-run motors described later.

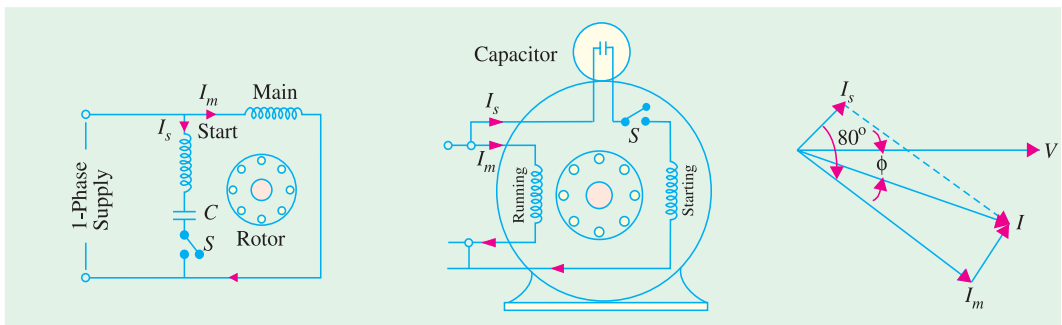

Fig. 36.10

Fig. 36.11

Fig. 36.12

**(ii) Capacitor-start Induction-run motors.** In these motors, the necessary phase difference between  $I_s$  and  $I_m$  is produced by connecting a capacitor in series with the starting winding as shown in Fig. 36.10. The capacitor is generally of the electrolytic type and is usually mounted on the outside of the motor as a separate unit (Fig. 36.11).

The capacitor is designed for extremely short-duty service and is guaranteed for not more than 20 periods of operation per hour, each period not to exceed 3 seconds. When the motor reaches about

75 per cent of full speed, the centrifugal switch  $S$  opens and cuts out both the starting winding and the capacitor from the supply, thus leaving only the running winding across the lines. As shown in Fig.



Capacitor start/capacitor-run motor.

36.12, current  $I_m$  drawn by the main winding lags the supply voltage  $V$  by a large angle whereas  $I_s$  leads  $V$  by a certain angle. The two currents are out of phase with each other by about  $80^\circ$  (for a 200-W 50-Hz motor) as compared to nearly  $30^\circ$  for a split-phase motor. Their resultant current  $I$  is small and is almost in phase with  $V$  as shown in Fig. 36.12.

Since the torque developed by a split-phase motor is proportional to the sine of the angle between  $I_s$  and  $I_m$ , it is obvious that the

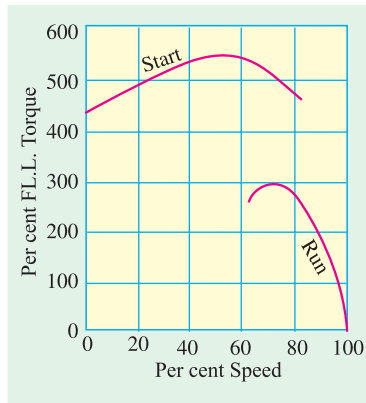

Fig. 36.13

increase in the angle (from  $30^\circ$  to  $80^\circ$ ) alone increases the starting torque to nearly twice the value developed by a standard split-phase induction motor. Other improvements in motor design have made it possible to increase the starting torque to a value as high as 350 to 450 per cent.

Typical performance curve of such a motor is shown in Fig. 36.13.

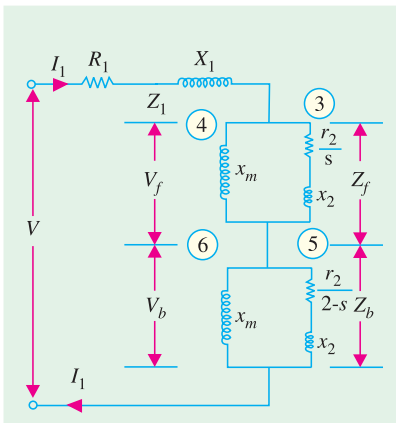

Fig. 36.14

### 36.5. Equivalent Circuit of a Single-phase Induction Motor-Without Core Loss

A single-phase motor may be looked upon as consisting of two motors, having a common stator winding, but with their respective rotors revolving in opposite directions. The equivalent circuit of such a motor based on double-field revolving theory is shown in Fig. 36.14. Here, the single-phase motor has been imagined to be made-up of (i) one stator winding and (ii) two imaginary rotors. The stator impedance is  $Z = R_1 + j X_1$ . The impedance of each rotor is  $(r_2 + jx_2)$  where  $r_2$  and  $x_2$  represent half the actual rotor values in stator terms (i.e.  $x_2$  stands for half the standstill reactance of the rotor, as referred to stator). Since iron loss has been neglected, the exciting branch is shown consisting of exciting reactance only. Each rotor has been assigned half the magnetising reactance\* (i.e.  $x_m$  represents half the actual reactance). The

impedance of 'forward running' rotor is

$$Z_f = \frac{j x_m \left( \frac{r_2}{s} + j x_2 \right)}{\frac{r_2}{s} + j (x_m + x_2)}$$

and it runs with a slip of  $s$ . The impedance of 'backward' running rotor is

\* In fact, full values are shown by capital letters and half values by small letters.

$$Z_b = \frac{j x_m \left( \frac{r_2}{2-s} + j x_2 \right)}{\frac{r_2}{2-s} + j (x_m + x_2)}$$

and it runs with a slip of  $(2 - s)$ . Under standstill conditions,  $V_f = V_b$ , but under running conditions  $V_f$  is almost 90 to 95% of the applied voltage.

The forward torque in synchronous watts is  $T_f = I_3^2 r_2 / s$ . Similarly, backward torque is  $T_b = I_5^2 r_2 / (2 - s)$

The total torque is  $T = T_f - T_b$ .

### 36.6. Equivalent Circuit-With Core Loss

The core loss can be represented by an equivalent resistance which may be connected either in parallel or in series with the magnetising reactance as shown in Fig. 36.15.

Since under running conditions  $V_f$  is very high (and  $V_b$  is correspondingly, low) most of the iron loss takes place in the ‘forward motor’ consisting of the common stator and forward-running rotor. Core-loss current  $I_w = \text{core loss} / V_f$ . Hence, half value of core-loss equivalent resistance is  $r_c = V_f / I_w$ . As shown in Fig. 36.15 (a),  $r_c$  has been connected in parallel with  $x_m$  in each rotor.

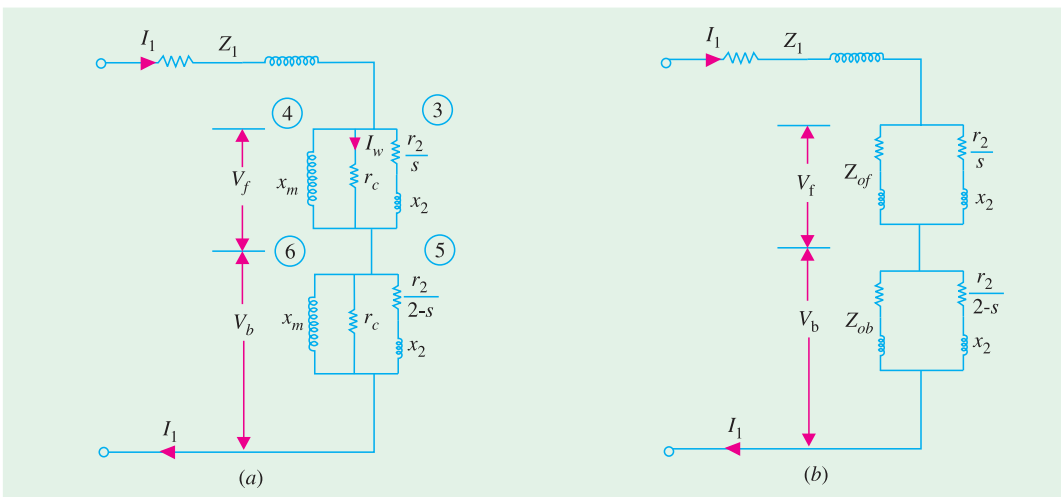

Fig. 36.15

**Example 36.1.** Discuss the revolving field theory of single-phase induction motors. Find the mechanical power output at a slip of 0.05 of the 185-W, 4-pole, 110-V, 60-Hz single-phase induction motor, whose constants are given below:

Resistance of the stator main winding	$R_1 = 1.86 \text{ ohm}$
Reactance of the stator main winding	$X_1 = 2.56 \text{ ohm}$
Magnetizing reactance of the stator main winding	$X_m = 53.5 \text{ ohm}$
Rotor resistance at standstill	$R_2 = 3.56 \text{ ohm}$
Rotor reactance at standstill	$X_2 = 2.56 \text{ ohm}$

(Elect. Machines, Nagpur Univ. 1991)

**Solution.** Here,  $X_m = 53.5 \Omega$ , hence  $x_m = 53.5/2 = 26.7 \Omega$

Similarly,  $r_2 = R_2 / 2 = 3.56 / 2 = 1.78 \Omega$  and  $x_2 = X_2 / 2 = 2.56 / 2 = 1.28 \Omega$



$$\therefore Z_f = \frac{j x_m \left( \frac{r_2}{s} + j x_2 \right)}{\frac{r_2}{s} + j (x_2 + x_m)} = x_m \frac{\frac{r_2}{s} \cdot x_m + j \left[ (r_2/s)^2 + x_2 x_0 \right]}{(r_2/s)^2 + x_0^2} \quad \text{where } x_0 = (x_m + x_2)$$

$$\therefore Z_f = 26.7 \frac{(1.78/0.05) \times 26.7 + j [(1.78/0.05)^2 + 1.28 \times 27.98]}{(1.78/0.05)^2 + (27.98)^2}$$

$$= 12.4 + j 17.15 = 21.15 \angle 54.2^\circ$$

Similarly,  $Z_b = \frac{j x_m \left( \frac{r_2}{2-s} + j x_2 \right)}{\frac{r_2}{2-s} + j (x_2 + x_m)} = x_m \frac{\left( \frac{r_2}{2-s} \right) x_m + j \left[ \left( \frac{r_2}{2-s} \right)^2 + x_0 x_2 \right]}{\left( \frac{r_2}{2-s} \right)^2 + x_0^2}$

$$= 26.7 \frac{(1.78/1.95) \times 26.7 + j [(1.78/1.95)^2 + 1.28 \times 27.98]}{(1.78/1.95)^2 + (27.98)^2}$$

$$= 0.84 + j 1.26 = 1.51 \angle 56.3^\circ$$

$$\mathbf{Z_1} = R_1 + j X_1 = 1.86 + j 2.56 = 3.16 \angle 54^\circ$$

Total circuit impedance is

$$\mathbf{Z_{01}} = \mathbf{Z_1} + \mathbf{Z_f} + \mathbf{Z_b} = (1.86 + j 2.56) + (12.4 + j 17.15) + (0.84 + j 1.26)$$

$$= 15.1 + j 20.97 = 25.85 \angle 54.3^\circ$$

Motor current  $I_1 = 110/25.85 = 4.27 \text{ A}$

$$V_f = I_1 Z_f = 4.27 \times 21.15 = 90.4 \text{ V}; V_b = I_1 Z_b = 4.27 \times 1.51 = 6.44 \text{ V}$$

$$Z_3 = \sqrt{\left( \frac{r_2}{s} \right)^2 + x_2^2} = 35.7 \Omega, Z_5 = \sqrt{\left( \frac{r_2}{2-s} \right)^2 + x_2^2} = 1.57 \Omega$$

$$I_3 = V_f / Z_3 = 90.4/35.7 = 2.53 \text{ A}, I_5 = V_b / Z_5 = 6.44/1.57 = 4.1 \text{ A}$$

$$T_f = I_3^2 R_2 / s = 228 \text{ synch. watts}, T_5 = I_5^2 r_2 / (2-s) = 15.3 \text{ synch. watts.}$$

$$T = T_f - T_b = 228 - 15.3 = 212.7 \text{ synch. watts}$$

$$\text{Output} = \text{synch. watt} \times (1-s) = 212.7 \times 0.95 = \mathbf{202 \text{ W}}$$

Since friction and windage losses are not given, this also represents the net output.

**Example 36.2.** Find the mechanical power output of 185-W, 4 pole, 110-V, 50-Hz single-phase induction motor, whose constants are given below at a slip of 0.05.

$$R_1 = 1.86 \Omega \quad X_1 = 2.56 \Omega \quad X_\phi = 53.5 \Omega \quad R_2 = 3.56 \Omega \quad X_2 = 2.56 \Omega$$

$$\text{Core loss} = 3.5 \text{ W, Friction and windage loss} = 13.5 \text{ W.}$$

(Electrical Machines-III, Indore Univ. 1987)

**Solution.** It would be seen that major part of this problem has already been solved in Example 36.1. Let us, now, assume that  $V_f = 82.5\%$  of 110 V = 90.7 V. Then the core-loss current  $I_c = 35/90.7 = 0.386 \text{ A}$ ;  $r_c = 90.7/0.386 = 235 \Omega$ .

#### Motor I

$$\text{conductance of core-loss branch} = 1/r_c = 1/235 = 0.00426 \text{ S}$$

$$\text{susceptance of magnetising branch} = -j/x_m = -j/26.7 = -j 0.0374 \text{ S}$$

$$\text{admittance of branch 3} = \frac{(r_2/s) - j x_2}{(r_2/s)^2 + x_2^2} = 0.028 - j 0.00101 \text{ S}$$

admittance of 'motor' I is  $Y_f = 0.00426 - j 0.0374 + 0.028 - j 0.00101$   
 $= 0.03226 - j 0.03841 \text{ S}$

impedance  $Z_f = 1/Y_f = 12.96 + j 15.2 \text{ or } 19.9 \Omega$

**Motor II**

$$\text{admittance of branch 5} = \frac{\frac{r_2}{2-s} - j x_2}{\left(\frac{r_2}{2-s}\right)^2 + x_2^2} = \frac{0.91 - j 1.28}{2.469} = 0.369 - j 0.517$$

admittance of 'motor' II,  $Y_b = 0.00426 - j 0.0374 + 0.369 - j 0.517$   
 $= 0.3733 - j 0.555 \text{ S}$

Impedance of 'motor' II,  $Z_b = 1/Y_b = 0.836 + j 1.242 \text{ or } 1.5 \Omega$

Impedance of entire motor (Fig. 36.16)  $Z_{01} = Z_1 + Z_f + Z_b = 15.66 + j 19 \text{ or } 24.7 \Omega$

$$I_1 = V/Z_{01} = 110/24.7 = 4.46 \text{ A}$$

$$V_f = I_1 Z_f = 4.46 \times 19.9 = 88.8 \text{ V}$$

$$V_b = 4.46 \times 1.5 = 6.69 \text{ V}$$

$$I_3 = 88.8/35.62 = 2.5 \text{ A}$$

$$I_5 = 6.69/1.57 = 4.25 \text{ A}$$

$$T_f = I_3^2 (r_2/s) = 222 \text{ synch. watt}$$

$$T_b = I_5^2 \left(\frac{r_2}{2-s}\right) = 16.5 \text{ synch. watt}$$

$$T = T_f - T_b = 205.5 \text{ synch. watt}$$

Watts converted = synch. watt (1 - s)  
 $= 205.5 \times 0.95 = 195 \text{ W}$

Net output =  $195 - 13.5 = 181.5 \text{ W}$ .

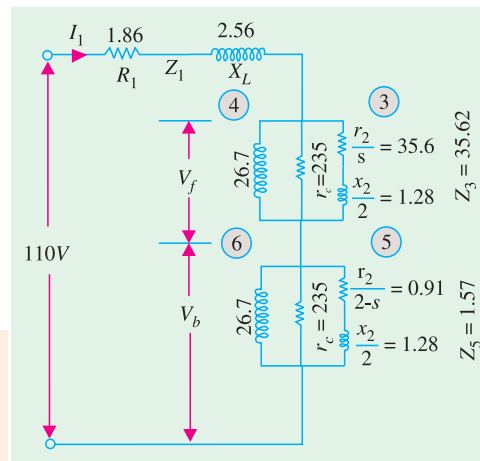

Fig. 36.16

**Example 36.3.** A 250-W, 230-V, 50-Hz capacitor-start motor has the following constants for the main and auxiliary windings: Main winding,  $Z_m = (4.5 + j 3.7) \text{ ohm}$ . Auxiliary winding  $Z_a = (9.5 + j 3.5) \text{ ohm}$ . Determine the value of the starting capacitor that will place the main and auxiliary winding currents in quadrature at starting.

(Electrical Machines-III, South Gujarat Univ. 1985)

**Solution.** Let  $X_C$  be the reactance of the capacitor connected in the auxiliary winding.

Then  $Z_a = 9.5 + j 3.5 - j X_C = (9.5 + jX)$   
 where  $X$  is the net reactance.

Now,  $Z_m = 4.5 + j 3.5 = 5.82 \angle 39.4^\circ \text{ ohm}$

Obviously,  $I_m$  lags behind  $V$  by  $39.4^\circ$

Since, time phase angle between  $I_m$  and  $I_a$  has to be  $90^\circ$ ,  $I_a$  must lead  $V$  by

$$(90^\circ - 39.4^\circ) = 50.6^\circ.$$

For auxiliary winding,  $\tan \phi_a = X/R$  or  $\tan 50.6^\circ = X/9.5$

or  $X = 9.5 \times 1.217 = 11.56 \Omega$  (capacitive)

$\therefore X_C = 11.56 + 3.5 = 15.06 \Omega \quad \therefore 15.06 = 1/314 C; C = 211 \mu\text{F}$

## Tutorial Problem No. 36.1.

1. A 1- $\phi$ , induction motor has stator windings in space quadrature and is supplied with a single-phase voltage of 200 V at 50 Hz. The standstill impedance of the main winding is  $(5.2 + j 10.1)$  and of the auxiliary winding is  $(19.7 + j 14.2)$ . Find the value of capacitance to be inserted in the auxiliary winding for maximum starting torque. *(Electrical Machines-III, Indore Univ. July, 1977)*

2. A 230-V, 50-Hz, 6-pole, single-phase induction motor has the following constants.

$$r_1 = 0.12 \Omega, r_2 = 0.14 \Omega, x_1 = x_2 = 0.25 \Omega, x_m = 15 \Omega.$$

If the core loss is 250 W and friction and windage losses are 500 W, determine the efficiency and torque at  $s = 0.05$ . *(Electrical Machines-IV, Bangalore Univ. Aug. 1978)*

3. Explain how the pulsating mmf of a single-phase induction motor may be considered equivalent to two oppositely-rotating fields. Develop an expression for the torque of the motor.

A 125-W, 4-pole, 110-V, 50-Hz single-phase induction motor has the no-load rotational loss of 25 watts and total rotor copper loss at rated load of 25 watts at a slip of 0.06. The rotor  $I^2R$  loss may be neglected.

At a slip  $s = 0.06$ , what is the power input to the machine ?

*(Electrical Machines-III, Indore Univ. July 1977)*

## 36.7. Types of Capacitor-start Motors

Some of the important types of such motors are given below :

## 1. Single-voltage, externally-reversible type

In this motor, four leads are brought outside its housing; two from the main winding and two from the starting-winding circuit. These four leads are necessary for external reversing. As usual, internally, the starting winding is connected in series with the electrolytic capacitor and a centrifugal switch. The direction of rotation of the motor can be easily reversed externally by reversing the starting winding leads with respect to the running winding leads.

## 2. Single-voltage, non-reversible type

In this case, the starting winding leads are connected internally to the leads of the running winding. Consequently, there are only two external leads in such motors. Obviously, direction of rotation cannot be reversed unless the motor is taken apart and leads of the starting winding reversed.

## 3. Single-voltage reversible and with thermostat type

Many motors are fitted with a device called thermostat which provides protection against overload, overheating, and short-circuits etc. The thermostat usually consists of a bimetallic element that is connected in series with the motor and is often mounted on the outside of the motor.

The wiring diagram of a capacitor-start motor fitted with this protective device is shown in Fig. 36.17. When due to some reasons, excessive current flows through the motor, it produces abnormal heating of the bimetallic strip with the result that it bends and opens the contact points thus disconnecting the motor from the supply lines. When the thermostat element cools, it automatically closes the contacts\*.

In the case of capacitor-start motors used for refrigerators, generally a terminal block is attached to the motor. Three out of the four block terminals are marked  $T$ ,  $TL$  and  $L$  as shown in Fig. 36.18. Thermostat is connected to  $T$  and  $TL$ , capacitor between  $L$  and the unmarked terminal and the supply lines to  $TL$  and  $L$ .

---

\* However, in some thermal units, a reset button has to be operated manually to restore the motor to operation. In certain types of thermal units, a heating element is used for heating the bimetallic strip. In that case, the heating element is connected in the line and the element or bimetallic strip is placed either inside the heating unit or besides it.

**4. Single-voltage, non-reversible with magnetic switch type**

Such motors are commonly used in refrigerators where it is not possible to use a centrifugal switch. The circuit diagram is similar to that shown in Fig. 36.6. Since their application requires just one direction of rotation, these motors are not connected for reversing.

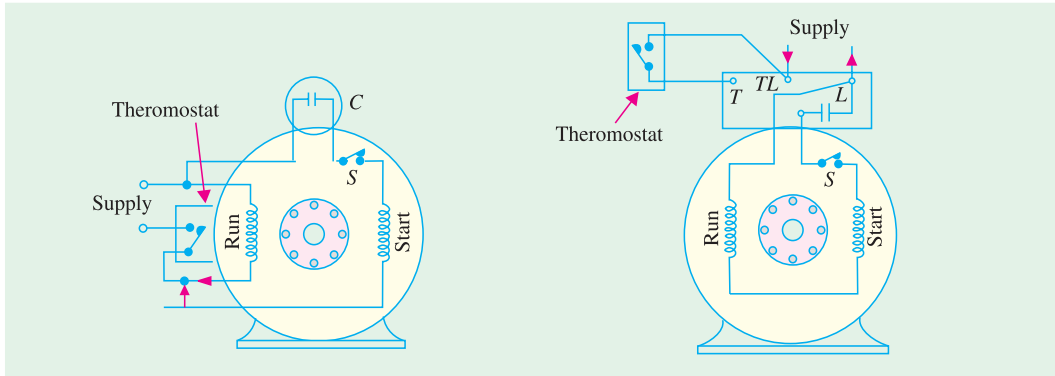

Fig. 36.17

Fig. 36.18

One disadvantage of a capacitor-start motor having magnetic switch lies in the possibility that slight overloads may operate the plunger thereby connecting the starting winding circuit to the supply. Since this winding is designed to operate for very short periods (3 seconds or less) it is likely to be burnt out.

**5. Two-voltage, non-reversible Type**

These motors can be operated from two a.c. voltage either 110 V and 220 V or 220 V and 440 V. Such motors have two main windings (or one main winding in two sections) and one starting winding with suitable number of leads brought out to permit changeover from one voltage to another.

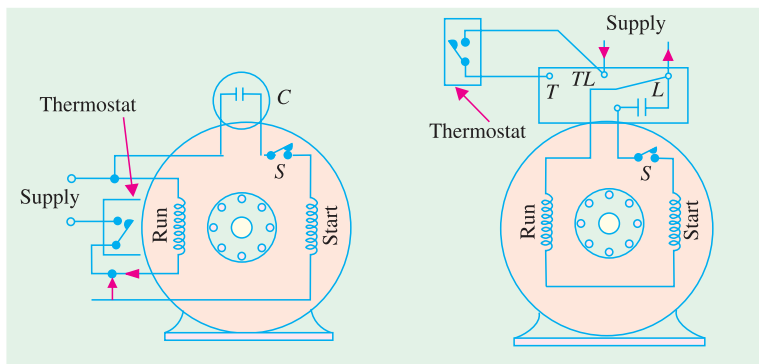

Fig. 36.19

Fig. 36.20

When the motor is to operate from lower voltage, the two main windings are connected in parallel (Fig. 36.19). Whereas for higher voltage, they are connected in series (Fig. 34.20). As will be seen from the above circuit diagrams, the starting winding is always operated on the low-voltage for which purpose it is connected across one of the main windings.

**6. Two-voltage, reversible type**

External reversing is made possible by means of two additional leads that are brought out from the starting winding.

Fig. 36.21 and 36.22 show connections for clockwise and anticlockwise rotations respectively when motor is operated from lower voltage. Similar wiring diagram can be drawn for higher voltage supply.

**7. Single-voltage, three-lead reversible type**

In such motors, a two-section running winding is used. The two sections  $R_1$  and  $R_2$  are internally connected in series and one lead of the starting winding is connected to the mid-point of  $R_1$  and  $R_2$ .

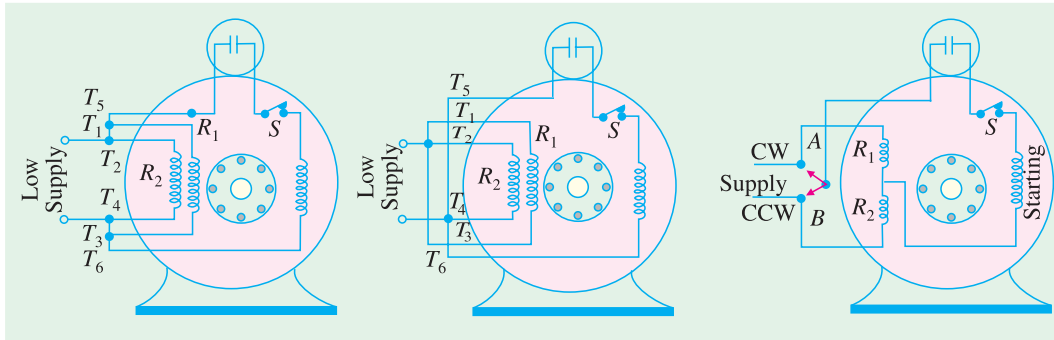

Fig. 36.21

Fig. 36.22

Fig. 36.23

The second lead of the starting winding and both leads of the running winding are brought outside as shown in Fig. 36.23. When the external lead of the starting winding is connected to point A, the winding is connected across  $R_1$  and the motor runs clockwise. When the lead of starter winding is connected to point B, it is connected across  $R_2$ . Since current flowing through starting winding is reversed, the motor runs in counter-clockwise direction.

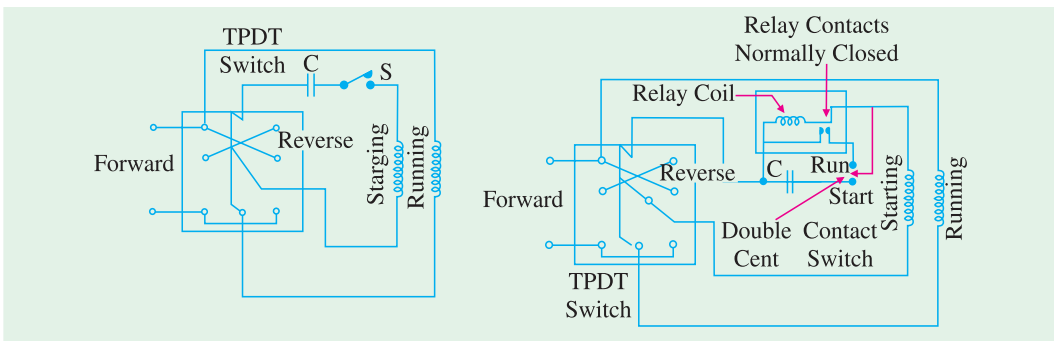

Fig. 36.24

Fig. 36.25

**8. Single-voltage, instantly-reversible type**

Normally, a motor must be brought to complete rest before it can be started in the reverse direction. It is so because the centrifugal switch cannot close unless the motor has practically stopped. Since starting winding is disconnected from supply when the motor is running, reversal of starting winding leads will not affect the operation of the motor. This reversal is achieved by a triple-pole, double-throw (TPDT) switch as shown in Fig. 36.24. The switch consists of three blades or poles which move together as one unit in either of the two positions. In one position of the switch (shown in one figure) motor runs clockwise and in the other, in counter-clockwise direction. Obviously, in this type of arrangement, it is necessary to wait till motor stops.

In certain applications where instant reversal is necessary while the motor is operating at full speed, a relay is fitted in the circuit to short-circuit the centrifugal switch and connect the starting winding in the circuit in the reversed direction (Fig. 36.25).

It will be seen that when at rest, the double-contact centrifugal switch is in the 'start' position. In this position, two connections are made :

- (i) the starting winding and capacitor  $C$  are placed in series across the supply line and
- (ii) the coil of the normally-closed relay is connected across  $C$

With the manual *TPDT* switch in the ‘forward’ position (a) running winding is connected across the line (b) starting winding and  $C$  are in series across the line and (c) relay coil is connected across  $C$ . The voltage developed across  $C$  is applied across the relay coil which results in opening of the relay contacts. With increase in the speed of the motor, the centrifugal switch is thrown in the ‘running’ position. This cuts out  $C$  from the circuit and leaves starting winding in series with the relay coil. Since relay coil has high resistance, it permits only enough current through the starting winding as to keep the relay contacts open.

During the fraction-of-a-second interval while *TPDT* switch is shifted from ‘forward’ to ‘reverse’ position, no current flows through the relay coil as a result of which the relay contacts close. When *TPDT* switch reaches the ‘reverse’ position, current flows through the now-closed relay contacts to the starting winding but in opposite direction. This produces a torque which is applied in a direction opposite to the rotation. Hence, (i) rotor is immediately brought to rest and (ii) centrifugal switch falls to the ‘start’ position. As before,  $C$  is put in series with the starter winding and the motor starts rotating in the opposite direction.

**9. Two-speed type**

Speed can be changed by changing the number of poles in the winding for which purpose two separate running windings are placed in the slots of the stator, one being 6-pole winding and the other, 8-pole winding. Only one starting winding is used which always acts in conjunction with the higher-speed running winding. The double-action or transfer type centrifugal switch  $S$  has two contact

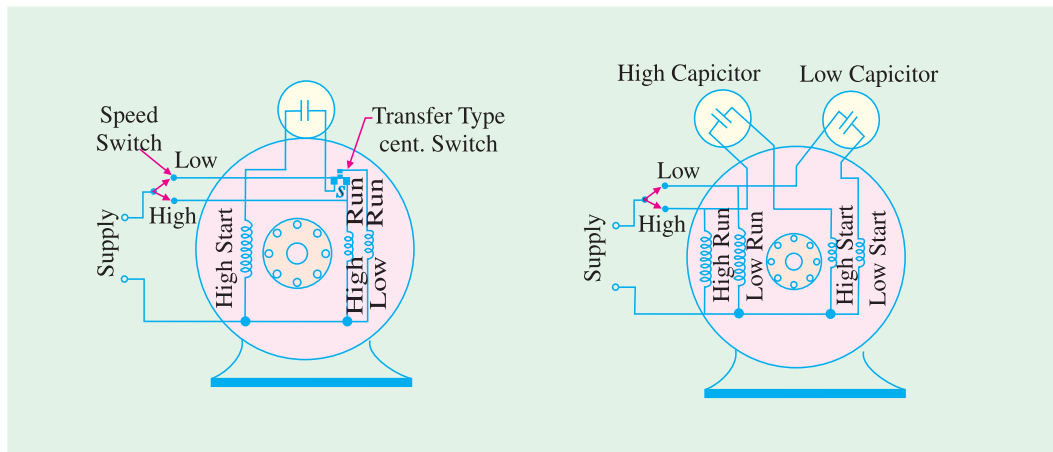

Fig. 36.26

Fig. 36.27

points on the ‘start’ side and one on the ‘run’ side. As shown in Fig. 36.26, an external speed switch is used for changing the motor speed. The motor will always start on high speed irrespective of whether the speed switch is on the ‘high’ or ‘low’ contact. If speed switch is set on ‘low’, then as soon as the motor comes up to speed, the centrifugal switch

- (a) cuts out the starting winding and high-speed running winding and
- (b) cuts in the low-speed running winding.

**10. Two-speed with two-capacitor type**

As shown in Fig. 36.27, this motor has two running windings, two starting windings and two capacitors. One capacitor is used for high-speed operation and the other for low-speed operation. A double centrifugal switch  $S$  is employed for cutting out the starting winding after start.

### 36.8. Capacitor Start-and-Run Motor

This motor is similar to the capacitor-start motor [Art.36.4 (ii)] except that the starting winding and capacitor are connected in the circuit at **all times**. The advantages of leaving the capacitor permanently in circuit are (i) improvement of over-load capacity of the motor (ii) a higher power factor (iii) higher efficiency and (iv) quieter running of the motor which is so much desirable for small power drives in offices and laboratories. Some of these motors which start and run with one value of capacitance in the circuit are called **single-value** capacitor-run motors. Other which start with high value of capacitance but run with a low value of capacitance are known as **two-value** capacitor-run motors.



Capacitor starts and run motor

#### (i) Single-value capacitor-Run Motor

It has one running winding and one starting winding in series with a capacitor as shown in Fig. 36.28. Since capacitor remains in the circuit permanently, this motor is often referred to as permanent-

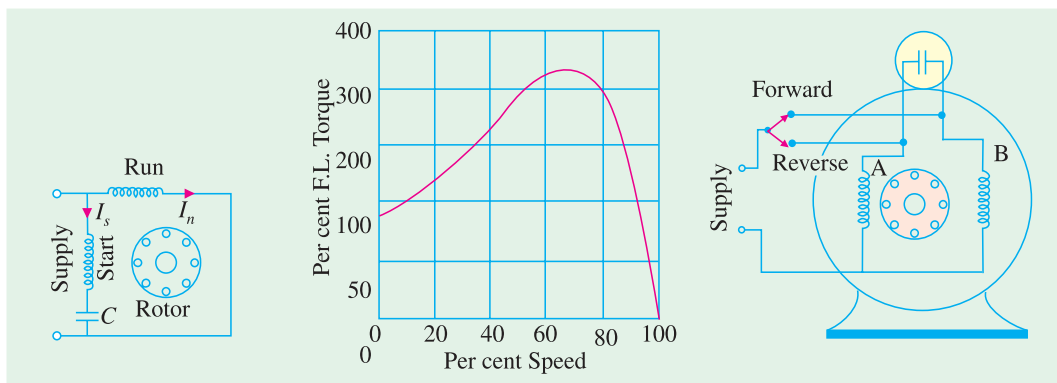

Fig. 36.28

Fig. 36.29

Fig. 36.30

split capacitor-run motor and behaves practically like an unbalanced 2-phase motor. Obviously, there is no need to use a centrifugal switch which was necessary in the case of capacitor-start motors. Since the same capacitor is used for starting and running, it is obvious that neither optimum starting nor optimum running performance can be obtained because value of capacitance used must be a compromise between the best value for starting and that for running. Generally, capacitors of 2 to 20  $\mu\text{F}$  capacitance are employed and are more expensive oil or pyranol-insulated foil-paper capacitors because of continuous-duty rating. The low value of the capacitor results in small starting torque which is about 50 to 100 per cent of the rated torque (Fig. 36.29). Consequently, these motors are used where the required starting torque is low such as air - moving equipment *i.e.* fans, blowers and voltage regulators and also oil burners where quiet operation is particularly desirable.

One unique feature of this type of motor is that it can be easily reversed by an external switch provided its **running and starting windings are identical**. One serves as the running winding and the other as a starting winding for one direction of rotation. For reverse rotation, the one that previously served as a running winding becomes the starting winding while the former starting winding serves as the running winding. As seen from Fig. 36.30 when the switch is in the forward position, winding B serves as running winding and A as starting winding. When switch is in 'reverse' position, winding A becomes the running winding and B the starting winding.

Such reversible motors are often used for operating devices that must be moved back and forth very frequently such as rheostats, induction regulations, furnace controls, valves and arc-welding controls.

**(ii) Two-value capacitor-Run Motor**

This motor starts with a high capacitor in series with the starting winding so that the starting torque is high. For running, a lower capacitor is substituted by the centrifugal switch. Both the running and starting windings remain in circuit.

The two values of capacitance can be obtained as follows:

1. by using two capacitors in parallel at the start and then switching out one for low-value run. (Fig. 36.31) or
2. by using a step-up auto-transformer in conjunction with one capacitor so that effective capacitance value is increased for starting purposes.

In Fig. 36.31, *B* is an electrolytic capacitor of high capacity (short duty) and *A* is an oil capacitor of low value (continuous duty). Generally, starting capacitor *B* is 10 to 15 times the running capacitor *A*. At the start, when the centrifugal switch is closed, the two capacitors are put in parallel, so that their combined capacitance is the sum of their individual capacitances. After the motor has reached 75 per cent full-load speed, the switch opens and only capacitor *A* remains in the starting winding circuit. In this way, both optimum starting and running performance is achieved in such motors. If properly designed, such motors have operating characteristics very closely resembling those displayed by two-phase motors. Their performance is characterised by

1. ability to start heavy loads  
 2. extremely quiet operation  
 3. higher efficiency and power factor  
 4. ability to develop 25 per cent overload capacity

Hence, such motors are ideally suited where load requirements are severe as in the case of compressors and fire strokers etc.

The use of an auto-transformer and single oil-type capacitor is illustrated in Fig.36.32. The transformer and capacitor are sealed in a rectangular iron box and mounted on top of the motor. The idea behind using this combination is that a capacitor of value *C* connected to the secondary of a step-up transformer, appears to the primary as though it had a value of  $K^2C$  where *K* is voltage transformation ratio. For example, if actual value of *C* = 4  $\mu$ F and *K* = 6, then low-voltage primary acts as if it had a 144  $\mu$ F (=  $6^2 \times 4$ ) capacitor connected across its terminals. Obviously, effective value of capacitance has increased 36 times. In the 'start' position of the switch, the connection is made to the

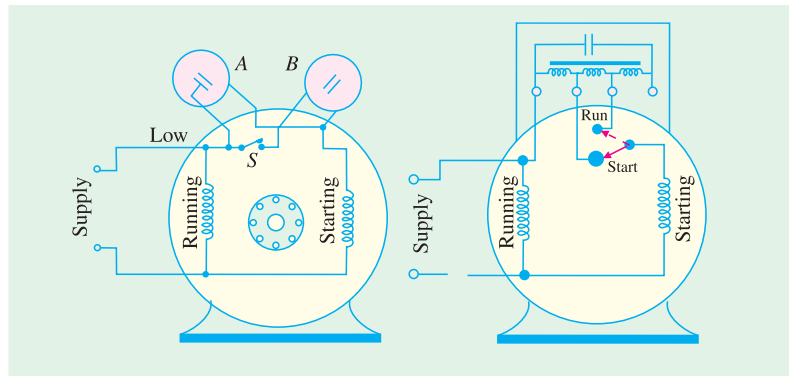

Fig. 36.31

Fig.36.32



Auto-transformer



mid-tap of the auto-transformer so that  $K = 2$ . Hence, effective value of capacitance at start is 4 times the running value and is sufficient to give a high starting torque. As the motor speeds up, the centrifugal switch shifts the capacitor from one voltage tap to another so that the voltage transformation ratio changes from higher value at starting to a lower value for running. The capacitor which is actually of the paper-tin-foil construction is immersed in a high grade insulation like wax or mineral oil.

### 36.9. Shaded-pole Single-phase Motor

In such motors, the necessary phase-splitting is produced by induction. These motors have salient poles on the stator and a squirrel-cage type rotor Fig. 36.33 shows a four-pole motor with the field poles connected in series for alternate polarity. One pole of such a motor is shown separately in Fig. 36.34. The laminated pole has a slot cut across the laminations approximately one-third distance from one edge. Around the small part of the pole is placed a short-circuited Cu coil known as *shading coil*. This part of the pole is known as *shaded* part and the other as *unshaded* part. When an alternating current is passed through the exciting (or field) winding



Shaded pole single phase motor

surrounding the whole pole, the axis of the pole shifts from the unshaded part *a* to the shaded part *b*. This shifting of the magnetic axis is, in effect, equivalent to the actual physical movement of the pole. Hence, the rotor starts rotating in the direction of this shift *i.e.* from unshaded part to the shaded part.

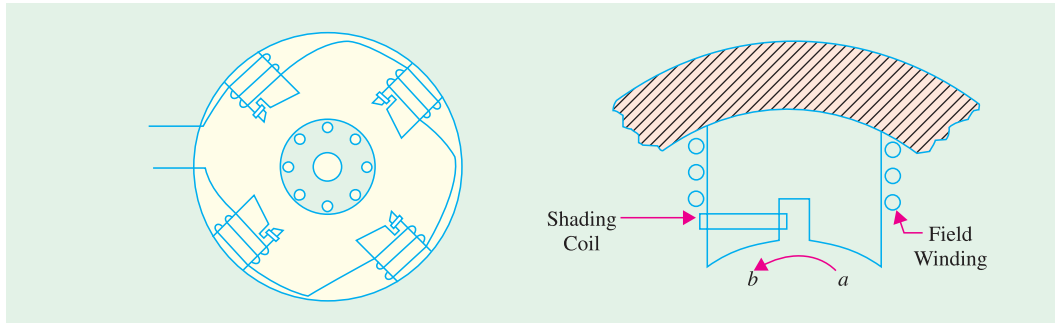

Fig. 36.33

Fig. 36.34

Let us now discuss why shifting of the magnetic axis takes place. It is helpful to remember that the shading coil is highly inductive. When the alternating current through exciting coil tends to increase, it induces a current in the shading coil by transformer action in such a direction as to oppose its growth. Hence, flux density decreases in the shaded part when exciting current increases. However, flux density increases in the shaded part when exciting current starts decreasing (it being assumed that exciting current is sinusoidal).

In Fig. 36.35 (a) exciting current is rapidly increasing along *OA* (shown by dots). This will produce an e.m.f. in the shading coil. As shading coil is of low resistance, a large current will be set up in such a direction (according to Lenz's law) as to oppose the rise of exciting current (which is responsible for its production). Hence, the flux mostly shifts to the unshaded part and the magnetic axis lies along the middle of this part *i.e.* along *NC*.

Next, consider the moment when exciting current is near its peak value *i.e.* from point *A* to *B* [Fig. 36.35 (b)]. Here, the change in exciting current is very slow. Hence, practically no voltage and, therefore, no current is induced in the shading coil. The flux produced by exciting current is at its maximum value and is uniformly distributed over the pole face. So the magnetic axis shifts to the centre of the pole *i.e.* along positions *ND*.

Fig. 36.35 (c) represents the condition when the exciting current is rapidly decreasing from *B* to *C*. This again sets up induced current in the shading coil by transformer action. This current will flow in such a direction as to oppose this decrease in exciting current, with the result that the flux is strengthened in the shaded part of the pole. Consequently, the magnetic axis shifts to the middle part of the shaded pole *i.e.* along *NE*.

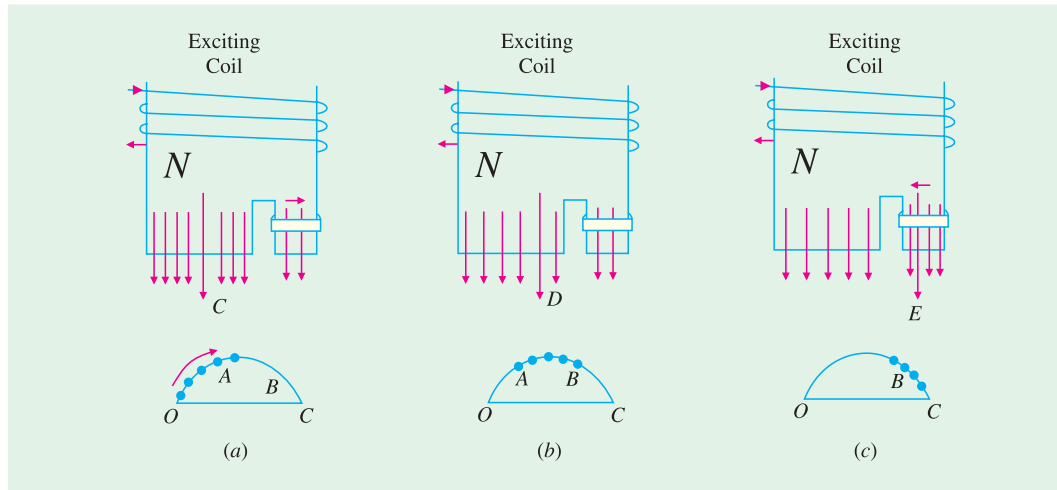

Fig. 36.35

From the above discussion we find that during the positive half-cycle of the exciting current, a *N*-pole shifts along the pole from the unshaded to the shaded part. During the next negative half-cycle of the exciting current, a *S*-pole trails along. The effect is as if a number of real poles were actually sweeping across the space from left to right.

Shaded pole motors are built commercially in very small sizes, varying approximately from 1/250 h.p. (3W) to 1/6 h.p. (125 W). Although such motors are simple in construction, extremely rugged, reliable and cheap, they suffer from the disadvantages of (i) low starting torque (ii) very little overload capacity and (iii) low efficiency. Efficiencies vary from 5% (for tiny sizes) to 35 (for higher ratings). Because of its low starting torque, the shaded-pole motor is generally used for small fans, toys, instruments, hair dryers, ventilators, circulators and electric clocks. It is also frequently used for such devices as churns, phonograph turntables and advertising displays etc. The direction of rotation of this motor cannot be changed, because it is fixed by the position of copper rings.

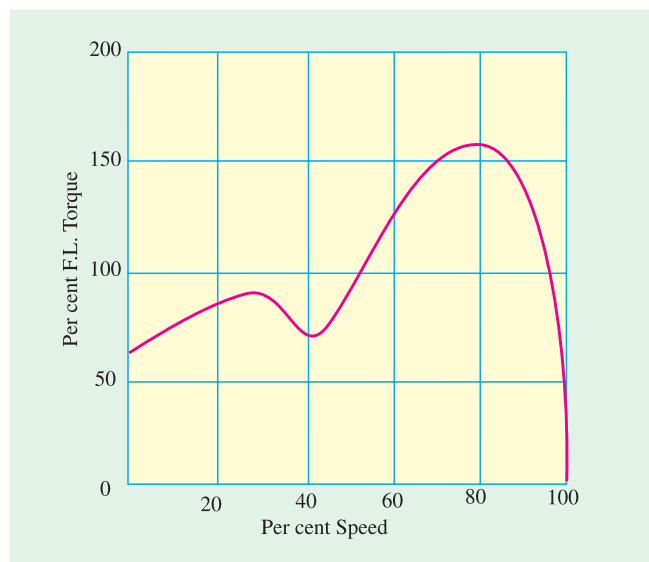

Fig. 36.36

A typical torque / speed curve for such a motor is shown in Fig. 36.36.

### 36.10. Repulsion Type Motors

These can be divided into the following four distinct categories :

- 1. Repulsion Motor.** It consists of (a) one stator winding (b) one rotor which is wound like a d.c. armature (c) commutator and (d) a set of brushes, which are short-circuited and remain in contact with the commutator at all times. It operates continuously on the 'repulsion' principle. No short-circuiting mechanism is required for this type.
- 2. Compensated Repulsion Motor.** It is identical with repulsion motor in all respects, except that (a) it carries an additional stator winding, called compensating winding (b) there is another set of two brushes which are placed midway between the usual short-circuited brush set. The compensating winding and this added set are connected in series.
- 3. Repulsion-start Induction-run Motor.** This motor starts as a repulsion motor, but normally runs as an induction motor, with constant speed characteristics. It consists of (a) one stator winding (b) one rotor which is similar to the wire-wound d.c. armature (c) a commutator and (d) a centrifugal mechanism which short-circuits the commutator bars all the way round (with the help of a short-circuiting necklace) when the motor has reached nearly 75 per cent of full speed.
- 4. Repulsion Induction Motor.** It works on the combined principle of repulsion and induction. It consists of (a) stator winding (b) two rotor windings : one squirrel cage and the other usual d.c. winding connected to the commutator and (c) a short-circuited set of two brushes.



Repulsion induction motor

It may be noted that repulsion motors have excellent characteristics, but are expensive and require more attention and maintenance than single-phase motors. Hence, they are being replaced by two-value capacitor motors for nearly all applications.

### 36.11. Repulsion Motor

Constructionally, it consists of the following :

- 1.** Stator winding of the distributed non-salient pole type housed in the slots of a smooth-cored stator (just as in the case of split-phase motors). The stator is generally wound for four, six or eight poles.
- 2.** A rotor (slotted core type) carrying a distributed winding (either lap or wave) which is connected to the commutator. The rotor is identical in construction to the d.c. armature.
- 3.** A commutator, which may be one of the two types : an axial commutator with bars parallel to the shaft or a radial or vertical commutator having radial bars on which brushes press horizontally.
- 4.** Carbon brushes (fitted in brush holders) which ride against the commutator and are used for conducting current through the armature (*i.e.* rotor) winding.

### 36.12. Repulsion Principle

To understand how torque is developed by the repulsion principle, consider Fig. 36.37 which shows a 2-pole salient pole motor with the magnetic axis vertical. For easy understanding, the stator winding has been shown with concentrated salient-pole construction (actually it is of distributed non-salient type). The basic functioning of the machine will be the same with either type of construction. As mentioned before, the armature is of standard d.c. construction with commutator and brushes (which are short-circuited with a low-resistance jumper).

Suppose that the direction of flow of the alternating current in the exciting or field (stator) winding is such that it creates a *N*-pole at the top and a *S*-pole at the bottom. The alternating flux produced by the stator winding will induce e.m.f. in the armature conductors by transformer action. The direction of the induced e.m.f. can be found by using Lenz's law and is as shown in Fig. 36.37 (a). However, the direction of the *induced* currents in the armature conductors will depend on the *positions of the short-circuited brushes*.

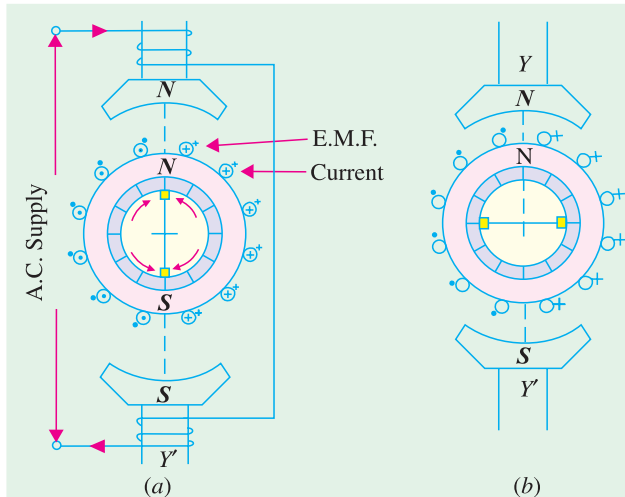

Fig. 36.37

If brush axis is colinear with magnetic axis of the main poles, the directions of the induced currents (shown by dots and arrows) will be as indicated in Fig. 36.37 (a)\*. As a result, the armature will become an electromagnet with a *N*-pole on its top, directly under the main *N*-pole and with a *S*-pole at the bottom, directly over the main *S*-pole. Because of this face-to-face positioning of the main and induced magnetic poles, no torque will be developed. The two forces of repulsion on top and bottom act along *Y Y'* in direct opposition to each other.\*\*

If brushes are shifted through 90° to the position shown in Fig. 36.37 (b) so that the brush axis is at right angles to

the magnetic axis of the main poles, the directions of the induced voltages at any time in the respective armature conductors are exactly the same as they were for the brush position of Fig. 36.37 (a). However, with brush positions of Fig. 36.37 (b), the voltages induced in the armature conductors in each path between the brush terminals will neutralize each other, hence there will be no net voltage across brushes to produce armature current. If there is no armature current, obviously, no torque will be developed.

If the brushes are set in position shown in Fig. 36.38 (a) so that the brush axis is neither in line with nor 90° from the magnetic axis *Y Y'* of the main poles, a net voltage\*\*\* will be induced between the brush terminals which will produce armature current. The armature will again act as an elec-

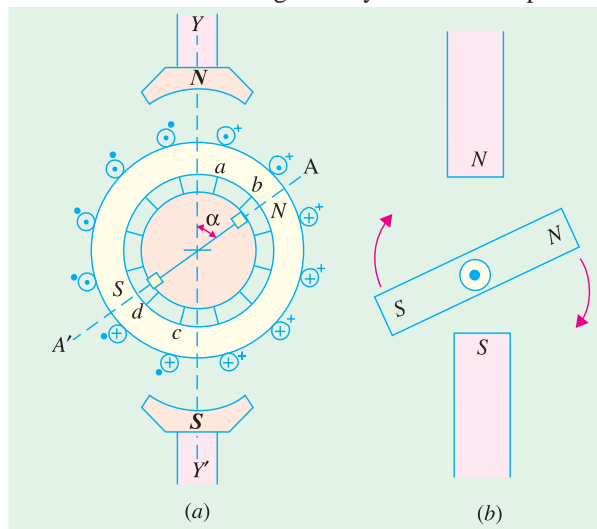

Fig. 36.38

\* It should be noted that during the next half-cycle of the supply current, the directions of the respective voltages will be in the opposite directions.

\*\* Alternatively, the absence of the torque may be explained by arguing that the torques developed in the four quadrants neutralize each other.

\*\*\* It will be seen from Fig. 36.38 (a) that the induced voltages in conductors *a* and *b* oppose the voltages in other conductors lying above brush-axis. Similarly, induced voltages in conductors *c* and *d* oppose the voltages in other conductors, lying below the brush-axis. Yet the net voltage across brush terminals will be sufficient to produce current which will make the armature a powerful magnet.

tromagnet and develop its own *N*- and *S*-poles which, in this case, will not directly face the respective main poles. As shown in Fig. 36.38 (a), the armature poles lie along *AA'* making an angle of  $\alpha$  with *YY*.

Hence, rotor *N*-pole will be repelled by the main *N*-pole and the rotor *S*-pole will, similarly, be repelled by the *main S*-pole. Consequently, the rotor will rotate in clockwise direction [Fig.36.38 (b)]. Since the forces are those of *repulsion*, it is appropriate to call the motor as repulsion motor.

It should be noted that if the brushes are shifted counter-clockwise from *YY'*, rotation will also be counter-clockwise. Obviously, direction of rotation of the motor is determined by the position of brushes with respect to the main magnetic axis.

It is worth noting that the value of starting torque developed by such a motor will depend on the *amount* of brush-shift whereas direction of rotation will depend on the *direction* of shift [Fig. 36.39 (a)]. Maximum starting torque is developed at some position where brush axis makes, an angle lying between  $0^\circ$  and  $45^\circ$  with the magnetic axis of main poles. Motor speed can also be controlled by means of brush shift. Variation of starting torque of a repulsion motor with brush-shift is shown in Fig. 36.39 (b).

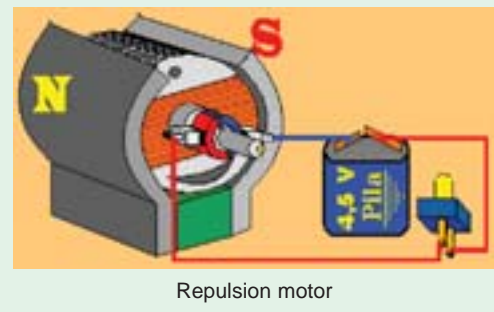

A straight repulsion type motor has high starting torque (about 350 per cent) and moderate starting current (about 3 to 4 times full-load value).

Principal shortcomings of such a motor are :

1. speed varies with changing load, becoming dangerously high at no load.
2. low power factor, except at high speeds.
3. tendency to spark at brushes.

### 36.13. Compensated Repulsion Motor

It is a modified form of the straight repulsion motor discussed above. It has an additional stator winding, called compensating winding whose purpose is (i) to improve power-factor and (ii) to provide better speed regulation. This winding is much smaller than the stator winding and is usually wound in the inner slots of each main pole and is connected in series with the armature (Fig. 36.40) through an additional set of brushes placed mid-way between the usual short-circuited brushes.

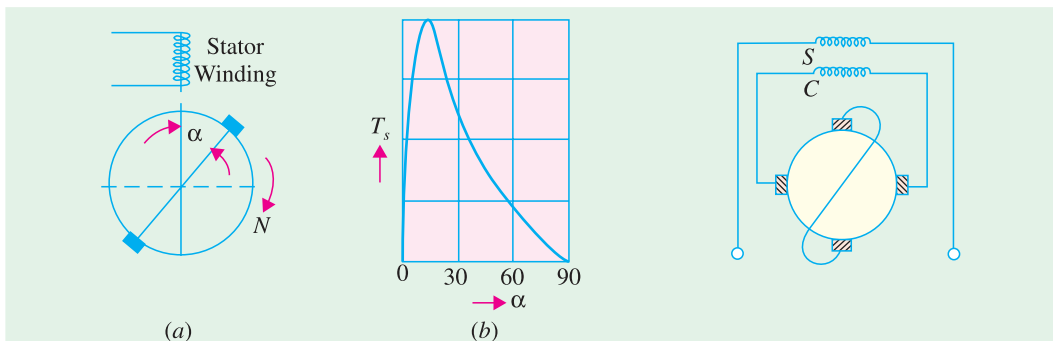

Fig. 36. 39

Fig. 36. 40

### 36.14. Repulsion-start Induction-Run Motor

As mentioned earlier, this motor starts as an ordinary repulsion motor, but after it reaches about 75 per cent of its full speed, centrifugal short-circuiting device short-circuits its commutator. From

then on, it runs as an induction motor, with a short-circuited squirrel-cage rotor. After the commutator is short-circuited, brushes do not carry any current, hence they may also be lifted from the commutator, in order to avoid unnecessary wear and tear and friction losses.

Repulsion-start motors are of two different designs :

1. Brush-lifting type in which the brushes are automatically lifted from the commutator when it is short-circuited. These motors generally employ radial form of commutator and are built both in small and large sizes.
2. Brush-riding type in which brushes ride on the commutator at all times. These motors use axial form of commutator and are always built in small sizes.

The starting torque of such a motor is in excess of 350 per cent with moderate starting current. It is particularly useful where starting period is of comparatively long duration, because of high inertia loads. Applications of such motors include machine tools, commercial refrigerators, compressors, pumps, hoists, floor-polishing and grinding devices etc.

### 36.15. Repulsion Induction Motor

In the field of repulsion motor, this type is becoming very popular, because of its good all-round characteristics which are comparable to those of a compound d.c. motor. It is particularly suitable for those applications where the load can be removed entirely by de-clutching or by a loose pulley.

This motor is a combination of the repulsion and induction types and is sometimes referred to as *squirrel-cage repulsion motor*. It possesses the desirable characteristics of a repulsion motor and the constant-speed characteristics of an induction motor.

It has the usual stator winding as in all repulsion motors. But there are two separate and independent windings in the rotor (Fig. 36.41).

- (i) a squirrel-cage winding and
- (ii) commutated winding similar to that of a d.c. armature.

Both these windings function during the *entire period* of operation of the motor. The commutated winding lies in the outer slots while squirrel-cage winding is located in the inner slots\*. At start, the commutated winding supplies most of the torque, the squirrel-cage winding being practically inactive because of its high reactance. When the rotor accelerates, the squirrel-cage winding takes up a larger portion of the load.

The brushes are short-circuited and ride on the commutator continuously. One of the advantages of this motor is that it requires no centrifugal short-circuiting mechanism. Sometimes such motors are also made with compensating winding for improving the power factor.

As shown in Fig. 36.42, its starting torque is high, being in excess of 300 per cent. Moreover, it has a fairly constant speed regulation. Its field of application includes house-hold refrigerators, garage air pumps, petrol pumps, compressors, machine tools, mixing machines, lifts and hoists etc.

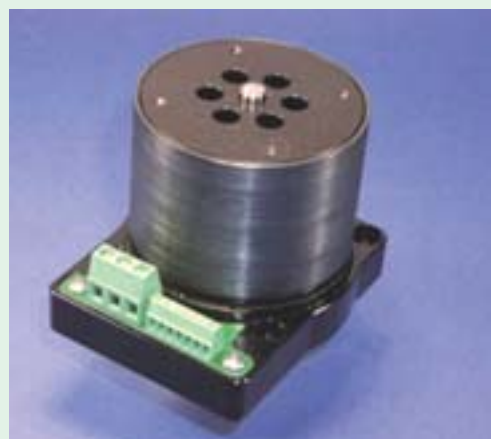

Brushless d.c. seromotor

\* Hence, commutated winding has low resistance whereas the squirrel-cage winding has inherently a high reactance.

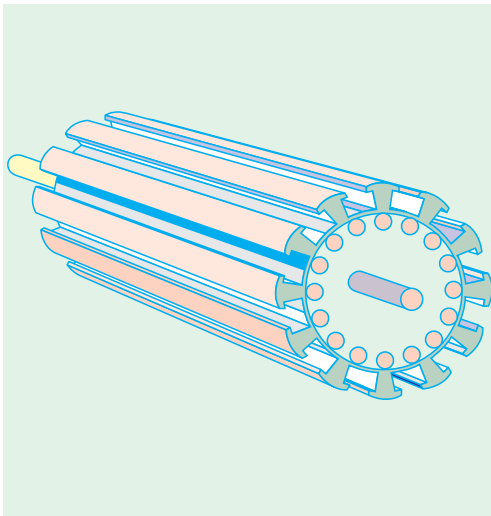

Fig. 36.41

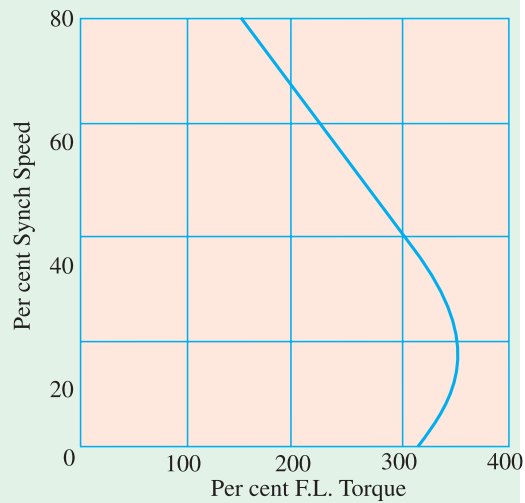

Fig. 36.42

These motors can be reversed by the usual brush-shifting arrangement.

### 36.16. A.C. Series Motors

If an ordinary d.c. series motor were connected to an a.c. supply, it will rotate and exert unidirectional torque\* because the current flowing both in the armature and field reverses at the same time. But the performance of such a motor will not be satisfactory for the following reasons :

1. the alternating flux would cause excessive eddy current loss in the yoke and field cores which will become extremely heated.
2. vicious sparking will occur at brushes because of the huge voltage and current induced in the short-circuited armature coils during their commutation period.
3. power factor is low because of high inductance of the field and armature circuits.



Induction type AC servo motor and control box

However, by proper modification of design and other refinements, a satisfactory single-phase motor has been produced.

The eddy current loss has been reduced by laminating the entire iron structure of the field cores and yoke.

Power factor improvement is possible only by reducing the magnitudes of the reactances of the field and armature windings. Field reactance is reduced by reducing the number of turns on the field windings. For a given current, it will reduce the field m.m.f. which will result in reduced air-gap flux. This will tend to increase the speed but reduce motor torque. To obtain the same torque, it will now be necessary to increase the number of armature turns proportionately. This will, however, result in increased inductive reactance of the armature, so that the overall reactance of the motor will not be

\* However, torque developed is not of constant magnitude (as in d.c. series motors) but pulsates between zero and maximum value each half-cycle.

significantly decreased. Increased armature m.m.f. can be neutralized effectively by using a compensating winding. In conductively-compensated motors, the compensating winding is connected in series with the armature [Fig. 36.43 (a)] whereas in inductively-compensated motors, the compensating winding is short-circuited and has no interconnection with the motor circuit [Fig. 36.43 (b)]. The compensating winding acts as a short-circuited secondary of a transformer, for which the armature winding acts as a primary. The current in the compensating winding will be proportional to the armature current and  $180^\circ$  out of phase with it.

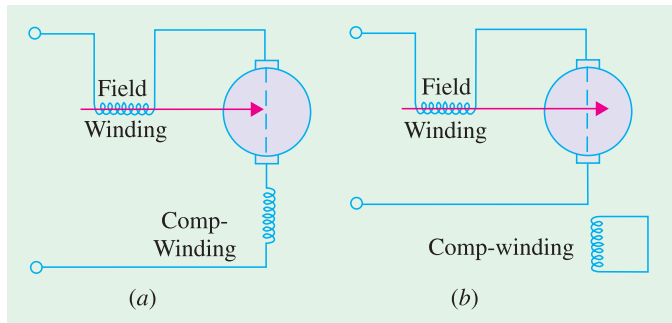

Fig. 36.43

Generally, all d.c. series motors are ‘provided’ with commutating poles for improving commutation (as in d.c. motors). But commutating poles alone will not produce satisfactory commutation, unless something is done to neutralize the huge voltage induced in the short-circuited armature coil by transformer action (this voltage is not there in d.c. series motor). It should be noted that in an a.c. series motor, the flux produced by the field winding is alternating and it induces voltage (by transformer action) in the short-circuited armature coil during its commutating period. The field winding, associated with the armature coil undergoing commutation, acts as primary and the armature coil during its commutating period acts as a short-circuited secondary. This transformer action produces heavy current in the armature coil as it passes through its commutating period and results in vicious sparking, unless the transformer voltage is neutralized. One method, which is often used for large motors, consists of shunting the winding of each commutating pole with a non-inductive resistance, as shown in Fig. 36.44 (a).

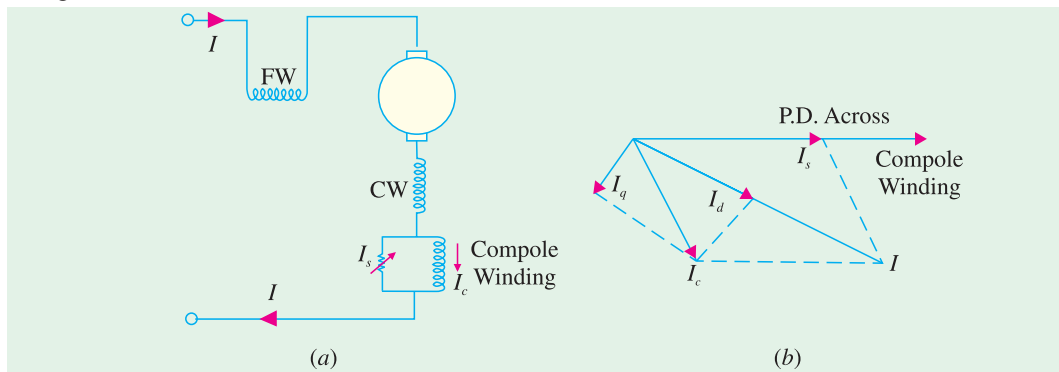

Fig. 36.44

Fig. 36.44. (b) shows the vector diagram of a shunted commutator pole. The current  $I_c$  through the commutating pole (which lags the total motor current) can be resolved into two rectangular components  $I_d$  and  $I_q$  as shown.  $I_d$  produces a flux which is in phase with total motor current  $I$  whereas flux produced by  $I_q$  lags  $I$  by  $90^\circ$ . By proper adjustment of shunt resistance (and hence  $I_s$ ), the speed voltage generated in a short-circuited coil by the cutting of the  $90^\circ$  lagging component of the commutating pole flux may be made to neutralize the voltage induced by transformer action.

### 36.17. Universal Motor

A universal motor is defined as a motor which may be operated either on direct or single-phase



a.c. supply at approximately the same speed and output.

In fact, it is a smaller version (5 to 150 W) of the a.c. series motor described in Art. 36.16. Being a series-wound motor, it has high starting torque and a variable speed characteristic. It runs at dangerously high speed on no-load. That is why such motors are usually built into the device they drive.

Generally, universal motors are manufactured in two types:

1. **concentrated-pole, non-compensated type** (low power rating)
2. **distributed-field compensated type** (high power rating)

The non-compensated motor has two salient poles and is just like a 2-pole series d.c. motor except that whole of its magnetic path is laminated (Fig. 36.45). The laminated stator is necessary because the flux is alternating when motor is operated from a.c. supply. The armature is of wound type and similar to that of a small d.c. motor. It consists essentially of a laminated core having either straight or skewed slots and a commutator to which the leads of the arma-



Universal motor.

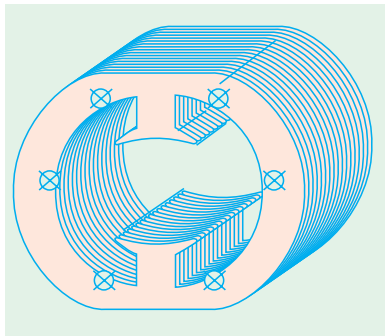

Fig. 36.45

ture winding are connected. The distributed-field compensated type motor has a stator core similar to that of a split-phase motor and a wound armature similar to that of a small d.c. motor. The compensating winding is used to reduce the reactance voltage present in the armature when motor runs on a.c. supply. This voltage is caused by the alternating flux by transformer action (Art. 36.16).

In a 2-pole non-compensated motor, the voltage induced by transformer action in a coil during its commutation period is not sufficient to cause any serious commutation trouble. Moreover, high-resistance brushes are used to aid commutation.

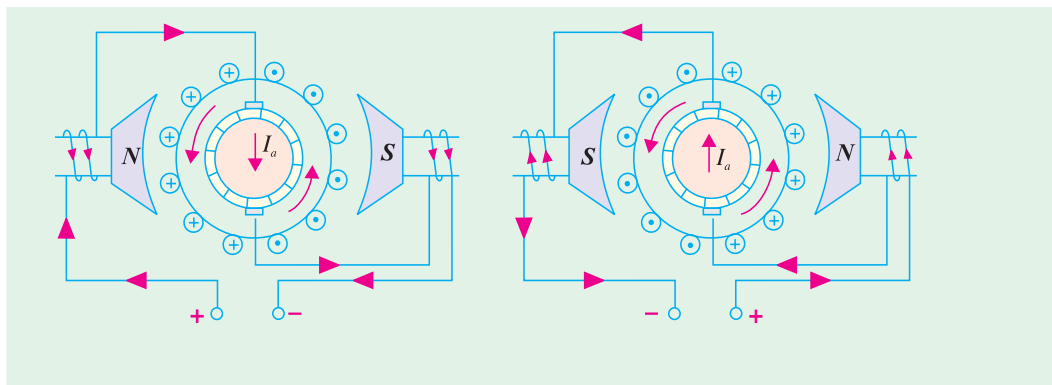

Fig. 36.46

Fig.36.47

**(a) Operation.** As explained in Art. 36.16, such motors develop unidirectional torque, regardless of whether they operate on d.c. or a.c. supply. The production of unidirectional torque, when the motor runs on a.c. supply can be easily understood from Fig. 36.46. The motor works on the same principle as a d.c. motor *i.e.* force between the main pole flux and the current-carrying armature conductors. This is true regardless of whether the current is alternating or direct (Fig. 36.47).

**(b) Speed/Load Characteristic.** The speed of a universal motor varies just like that of a d.c. series motor *i.e.* low at full-load and high on no-load (about 20,000 r.p.m. in some cases). In fact, on no-load the speed is limited only by its own friction and windage load. Fig. 36.48 shows typical torque characteristics of a universal motor both for d.c. and a.c. supply. Usually, gear trains are used to reduce the actual load speeds to proper values.

**(c) Applications.** Universal motors are used in vacuum cleaners where actual motor speed is the load speed. Other applications where motor speed is reduced by a gear train are : drink and food mixers, portable drills and domestic sewing machine etc.

**(d) Reversal of Rotation.** The concentrated-pole (or salient-pole) type universal motor may be reversed by reversing the flow of current through either the armature or field windings. The usual method is to interchange the leads on the brush holders (Fig.36.49).

The distributed-field compensated type universal motor may be reversed by interchanging either the armature or field leads and shifting the brushes against the direction in which the motor will rotate. The extent of brush shift usually amounts to several commutator bars.

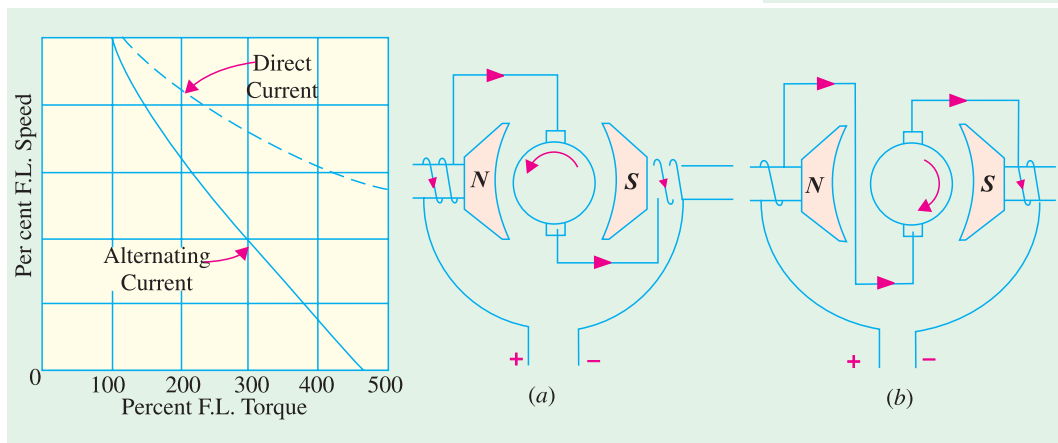
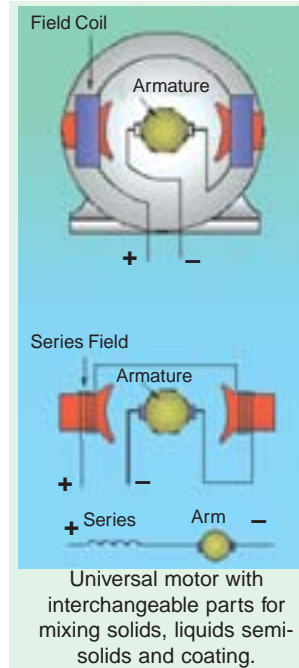

Fig. 36.48

Fig.36.49

### 36.18. Speed Control of Universal Motors

The following methods are usually employed for speed-control purposes :

**(i) Resistance Method.** As shown in Fig. 36.50, the motor speed is controlled by connecting a variable resistance  $R$  in series with the motor. This method is employed for motors used in sewing machines. The amount of resistance in the circuit is changed by means of a foot-pedal.

**(ii) Tapping-field Method.** In this method, a field pole is tapped at various points and speed is controlled by varying the field strength (Fig. 36.51). For this purpose, either of the following two arrangements may be used :

- (a)** The field pole is wound in various sections with different sizes of wire and taps are brought out from each section.
- (b)** Nichrome resistance wire is wound over one field pole and taps are brought out from this wire.

(iii) **Centrifugal Mechanism.** Universal motors, particularly those used for home food and drink mixers, have a number of speeds. Selection is made by a centrifugal device located inside the motor and connected, as shown in Fig. 36.52. The switch is adjustable by means of an external lever. If the motor speed rises above that set by the lever, the centrifugal device opens two contacts and inserts resistance  $R$  in the circuit, which causes the motor speed to decrease. When motor runs slow, the two contacts close and short-circuit the resistance, so that the motor speed rises. This process is repeated so rapidly that variations in speed are not noticeable.



Universal motor used for home food and drink mixers

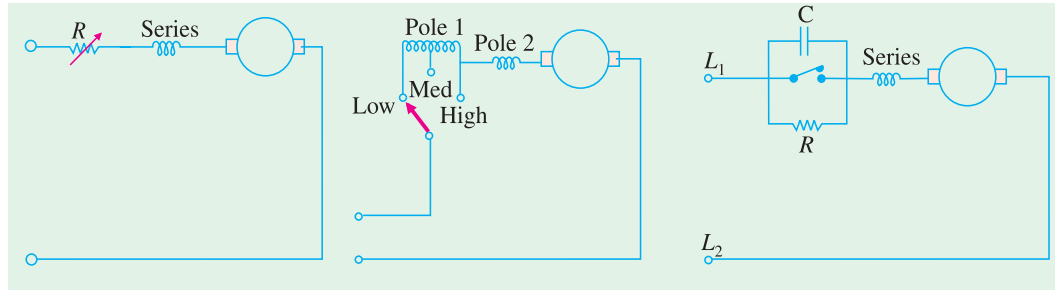

Fig. 36.50

Fig. 36.51

Fig. 36.52

The resistance  $R$  is connected across the governor points as shown in Fig. 36.52. A capacitor  $C$  is used across the contact points in order to reduce sparking produced due to the opening and closing of these points. Moreover, it prevents the pitting of contacts.

**Example 36.4.** A 250-W, single-phase, 50-Hz, 220-V universal motor runs at 2000 rpm and takes 1.0 A when supplied from a 220-V dc. supply. If the motor is connected to 220-V ac supply and takes 1.0 A (r.m.s), calculate the speed, torque and power factor. Assume  $R_a = 20 \Omega$  and  $L_a = 0.4$  H.

**Solution. DC Operation :**  $E_{b,dc} = V - I_a R_a$   
 $= 220 - 20 \times 1 = 200$  V

**AC Operation**

$X_a = 2 \pi \times 50 \times 0.4 = 125.7 \Omega$ .

As seen from Fig.36.53.

$V^2 = (E_{b,ac} + I_a R_a)^2 + (I_a \times X_a)^2$

$\therefore E_{b,ac} = -I_a R_a + \sqrt{V^2 - (I_a X_a)^2}$

$= -1 \times 20 + \sqrt{220^2 - (125.7 \times 1)^2} = 160.5$  V

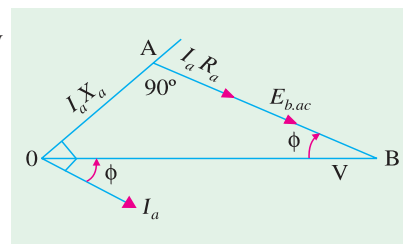

Fig. 36.53

Since armature current is the same for both dc and ac excitations, hence

$\frac{E_{b,dc}}{E_{b,ac}} = \frac{N_{dc}}{N_{ac}} ; \quad \therefore N_{ac} = 2000 \times \frac{160.5}{200} = 1605$  rpm

$\cos \phi = AB/OB = (E_{b,ac} + I_a R_a) / V = (160.5 + 20) / 220 = 0.82$  lag

$$P_{mech} = E_{b.ac} \cdot I_a = 160.5 \times 1 = 160.5 \text{ W}$$

$$T = 9.55 \times 160.5/1605 = \mathbf{0.955 \text{ N-m}}$$

**Example 36.5.** A universal series motor has resistance of  $30 \Omega$  and an inductance of  $0.5 \text{ H}$ . When connected to a  $250 \text{ V d.c.}$  supply and loaded to take  $0.8 \text{ A}$ , it runs at  $2000 \text{ r.p.m.}$  Estimate its speed and power factor, when connected to a  $250\text{-V, } 50\text{-Hz a.c.}$  supply and loaded to take the same current. (Elect. Machine, A.M.I.E. Sec. B, 1992)

**Solution. A.C. Operation**

$$X_a = 2 \pi \times 50 \times 0.5 = 157 \Omega,$$

$$R_a = 30 \Omega$$

$$I_a R_a = 0.8 \times 30 = 24 \Omega$$

$$I_a X_a = 0.8 \times 157 = 125.6 \text{ V}$$

The phasor diagram is shown in Fig. 36.54 (b)

$$V^2 = (E_{b.ac} + I_a R_a)^2 + (I_a X_a)^2$$

$$250^2 = (E_{b.ac} + 24)^2 + 125.6^2$$

$$\therefore E_{b.ac} = 192.6$$

**DC Operation**

$$E_{b.dc} = 250 - 0.8 \times 30 = 226 \text{ V}$$

Now,  $\frac{E_{b.ac}}{E_{b.dc}} = \frac{N_{ac}}{N_{dc}}$  or  $\frac{192.12}{226} = \frac{N_{ac}}{2000}$  ;

$$N_{ac} = 1700 \text{ rpm}$$

$$\cos \phi = (E_{b.ac} + I_a R_a)/V = 236.12/250 = \mathbf{0.864 \text{ lag}}$$

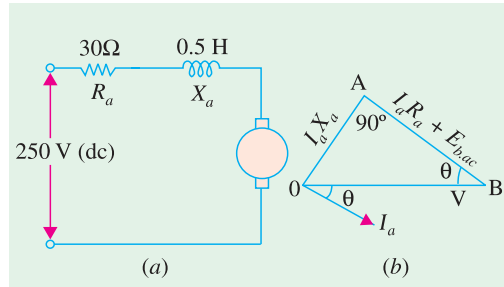

Fig. 36.54

**36.19. Unexcited Single-phase Synchronous Motors**

These motors

1. operate from a single-phase a.c. supply
2. run at a constant speed – the synchronous speed of the revolving flux
3. need no d.c. excitation for their rotors (that is why they are called *unexcited*)
4. are self-starting.

These are of two types (a) reluctance motor and (b) hysteresis motor.

**36.20. Reluctance Motor**

It has either the conventional split-phase stator and a centrifugal switch for cutting out the auxiliary winding (split-phase type reluctance motor) or a stator similar to that of a permanent-split capacitor-run motor (capacitor-type reluctance motor). The stator produces the revolving field.

The squirrel-cage rotor is of unsymmetrical magnetic construction. This type of unsymmetrical construction can be achieved by removing some of the teeth of a symmetrical squirrel-cage rotor punching. For example, in a 48-teeth, four-pole rotor following teeth may be cut away :

- 1, 2, 3, 4, 5, 6–13, 14, 15, 16, 17, 18–25, 26, 27, 28, 29, 30–37, 38, 39, 40, 41, 42.

This would leave four projecting or salient poles (Fig. 36.55) consisting of the following sets of teeth : 7–12; 19–24; 31–36 and 43–48. In this way, the rotor offers variable magnetic reluctance to the stator flux, the reluctance varying with the position of the rotor.

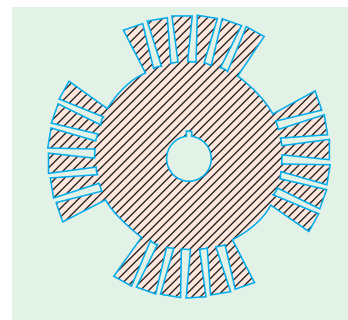

Fig. 36.55

### Working

For understanding the working of such a motor one basic fact must be kept in mind. And it is that when a piece of magnetic material is located in a magnetic field, a force acts on the material, tending to bring it into the most dense portion of the field. The force tends to align the specimen of material in such a way that the reluctance of the magnetic path that lies through the material will be minimum.

When the stator winding is energised, the revolving magnetic field exerts reluctance torque on the unsymmetrical rotor tending to align the salient pole axis of the rotor with the axis of the revolving magnetic field (because in this position, the reluctance of the magnetic path is minimum). If the reluctance torque is sufficient to start the motor and its load, the rotor will pull into step with the revolving field and continue to run at the speed of the revolving field.\*

However, even though the rotor revolves synchronously, its poles lag behind the stator poles by a certain angle known as torque angle, (something similar to that in a synchronous motor). The reluctance torque increases with increase in torque angle, attaining maximum value when  $\alpha = 45^\circ$ . If  $\alpha$  increases beyond  $45^\circ$ , the rotor falls out of synchronism. The average value of the reluctance torque is given by  $T = K (V/f)^2 \sin 2\delta$  where  $K$  is a motor constant.

It may be noted that the amount of load which a reluctance motor could carry at its *constant speed* would only be a fraction of the load that the motor could normally carry when functioning as an induction motor. If the load is increased beyond a value under which the reluctance torque cannot maintain synchronous speed, the rotor drops out of step with the field. The speed, then, drops to some value at which the slip is sufficient to develop necessary torque to drive the load by induction-motor action.

The constant-speed characteristic of a reluctance motor makes it very suitable for such applications as signalling devices, recording instruments, many kinds of timers and phonographs etc.

### 36.21. Hysteresis Motor

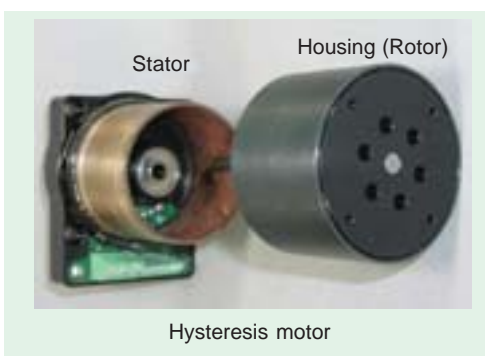

The operation of this motor depends on the presence of a *continuously-revolving* magnetic flux. Hence, for the split-phase operation, its stator has two windings which remain connected to the single-phase supply continuously both at starting as well as during the running of the motor. Usually, shaded-pole principle is employed for this purpose giving shaded-pole hysteresis motor. Alternatively, stator winding of the type used in capacitor-type motor may be used giving capacitor-type shaded-pole motor. Obviously, in either type, no centrifugal device is used.

The rotor is a smooth chrome-steel cylinder\*\* having

\* Actually, the motor starts as an induction motor and after it has reached its maximum speed as an induction motor, the reluctance torque pulls its rotor into step with the revolving field so that the motor now runs as a synchronous motor by virtue of its saliency.

\*\* Rotors of ceramic permanent magnet material are used whose resistivity approaches that of an insulator. Consequently, it is impossible to set up eddy currents in such a rotor. Hence, there is no eddy current loss but only hysteresis loss.

high retentivity so that the hysteresis loss is high. It has no winding. Because of high retentivity of the rotor material, it is very difficult to change the magnetic polarities once they are induced in the rotor by the revolving flux. The rotor revolves synchronously because the rotor poles magnetically lock up with the revolving stator poles of opposite polarity. However, the rotor poles always lag behind the stator poles by an angle  $\alpha$ . Mechanical power developed by rotor is given by  $P_m = P_h \left( \frac{1-s}{s} \right)$  where  $P_h$  is hysteresis loss in rotor. Also  $T_h = 9.55 P_m / N_s$ . It is seen that hysteresis torque depends solely on the area of rotor's hysteresis loop.

The fact that the rotor has no teeth or winding of any sort, results in making the motor extremely quiet in operation and free from mechanical and magnetic vibrations. This makes the motor particularly useful for driving tape-decks, tape-decks, turn-tables and other precision audio equipment. Since, commercial motors usually have two poles, they run at 3,000 r.p.m. at 50-Hz single-phase supply. In order to adopt such a motor for driving an electric clock and other indicating devices, gear train is connected to the motor shaft for reducing the load speed. The unit accelerates rapidly, changing from rest to full speed almost instantaneously. It must do so because it cannot accelerate gradually as an ordinary motor it is either operating at synchronous speed or not at all.

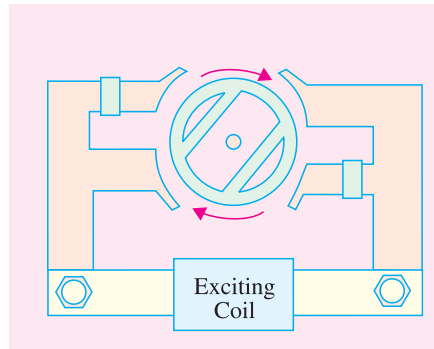

Fig. 36.56

Some unique features of a hysteresis motor are as under :

- (i) since its hysteresis torque remains practically constant from locked rotor to synchronous speed, a hysteresis motor is able to synchronise any load it can accelerate—something no other motor does.
- (ii) due to its smooth rotor, the motor operates quietly and does not suffer from magnetic pulsations caused by slots/salient-poles that are present in the rotors of other motors.

In Fig. 36.56. is shown a two-pole shaded-pole type hysteresis motor used for driving ordinary household electric clocks. The rotor is a thin metal cylinder and the shaft drives a gear train.

**Example 36.6.** A 8-kW, 4-pole, 220-V, 50-Hz reluctance motor has a torque angle of  $30^\circ$  when operating under rated load conditions. Calculate (i) load torque (ii) torque angle if the voltage drops to 205 V and (iii) will the rotor pulled out of synchronism ?

**Solution.** (i)  $N_s = 120 \times 50/4 = 1500$  rpm;  $T_{sh} = 9.55 \times \text{output}/N = 9.55 \times 8000/1500 = 51N\text{-m}$

(ii) With the same load torque and constant frequency,

$$V_1 \sin 2\alpha_1 = V_2^2 \sin 2\alpha_2$$

$$\therefore 220^2 \times \sin (2 \times 30^\circ) = 205^2 \times \sin 2\alpha; \quad \therefore \alpha = 42.9^\circ$$

(iii) since the new load angle is less than  $45^\circ$ , the rotor will not pull out of synchronous.

### Tutorial Problems-36.2.

1. A 230-V, 50-Hz, 4-pole, class-A, single-phase induction motor has the following parameters at an operating temperature  $63^\circ\text{C}$  :

$$r_{1m} = 2.51 \text{ ohms}, r_2' = 7.81 \text{ ohm}, X_m = 150.88 \text{ ohm}, X_{im} = 4.62 \text{ ohm}, X_2' = 4.62 \text{ ohms}$$

Determine stator main winding current and power factor when the motor is running at a slip of 0.05 at the specified temperature of  $63^\circ\text{C}$ .

[3.74  $\angle 48.24^\circ$ , 0.666] (AMIE Sec. B Elect. Machines (E-B) Summer 1991)

2. A fractional horse-power universal motor has armature circuit resistance of 20 ohm and inductance of 0.4 H. On being connected to a 220-V d.c. supply, it draws 1.0 A from the mains and runs at 2000 r.p.m. Estimate the speed and power factor of the motor, when connected to a 230-V, 50-Hz supply drawing the same armature current. Draw relevant phasor diagram.  
 [1726 rpm, 0.84] (AMIE Sec. B Elect. Machines 1991)
3. A universal series motor, when operating on 220 V d.c. draws 10 A and runs at 1400 r.p.m. Find the new speed and power factor, when connected to 220 V, 25 Hz supply, the motor current remaining the same. The motor has total resistance of 1 ohm and total inductance of 0.1 H.  
 [961 rpm; 0.7] (AMIE Sec. B Elect. Machines 1990)

QUESTIONS AND ANSWERS ON SINGLE-PHASE MOTORS

**Q.1. How would you reverse the direction of rotation of a capacitor start-induction-run motor ?**

**Ans.** By reversing either the running or starting-winding leads where they are connected to the lines. Both must not be reversed.

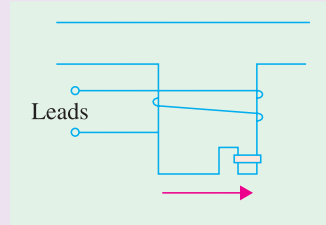

Fig. 36.57

**Q.2. In which direction does a shaded-pole motor run ?**

**Ans.** It runs from the unshaded to the shaded pole (Fig.36.57)

**Q.3. Can such a motor be reversed ?**

**Ans.** Normally, such motors are not reversible because that would involve mechanical dismantling and re-assembly. However, special motors are made having two rotors on a common shaft, each having one stator assembly for rotation in opposite direction.

**Q.4. What is a universal motor ?**

**Ans.** It is built like a series d.c. motor with the difference that both its stator and armature are laminated. They can be used either on d.c. or a.c. supply although the speed and power are greater on direct current. They cannot be satisfactorily made to run at less than about 2000 r.p.m.

**Q.5. How can a universal motor be reversed ?**

**Ans.** By reversing either the field leads or armature leads but not both.

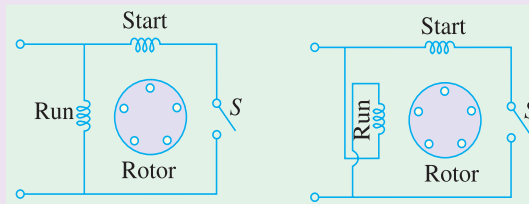

Fig. 36.58

**Q.6. How can we reverse the direction of rotation of repulsion, repulsion-induction and repulsion-induction and repulsion- start-induction-run motors ?**

**Ans.** By shifting the brush positions by about 15° electrical.

**Q.7. How can we reverse the rotation of a 1-phase, split-phase motor ?**

**Ans.** By reversing the leads to either the running or starter winding (Fig. 36.58) but not both.

**Q.8. What could be the reasons if a repulsion-induction motor fails to start ?**

**Ans.** Any one of the following :

1. no supply voltage
2. low voltage
3. excessive overload
4. the bearing lining may be stuck or 'frozen' to the shaft
5. armature may be rubbing
6. brush yoke may be incorrectly located
7. brush spacing may be wrong.

**Q.9. What could be the reasons if a split-phase motor fails to start and hums loudly ?**

**Ans.** It could be due to the starting winding being open or grounded or burnt out.

**Q.10. What could be the reasons if a split-phase motor runs too slow ?**

**Ans.** Any one of the following factors could be responsible :

1. wrong supply voltage and frequency
2. overload
3. grounded starting and running windings
4. short-circuited or open winding in field circuit.

### OBJECTIVE TESTS – 36

1. The starting winding of a single-phase motor is placed in the
  - (a) rotor
  - (b) stator
  - (c) armature
  - (d) field.
2. One of the characteristics of a single-phase motor is that it
  - (a) is self-starting
  - (b) is not self-starting
  - (c) requires only one winding
  - (d) can rotate in one direction only.
3. After the starting winding of a single-phase induction motor is disconnected from supply, it continues to run only on .....winding.
  - (a) rotor
  - (b) compensating
  - (c) field
  - (d) running
4. If starting winding of a single-phase induction motor is left in the circuit, it will
  - (a) draw excessive current and overheat
  - (b) run slower
  - (c) run faster
  - (d) spark at light loads.
5. The direction of rotation of a single-phase motor can be reversed by
  - (a) reversing connections of both windings
  - (b) reversing connections of starting winding
  - (c) using a reversing switch
  - (d) reversing supply connections.
6. If a single-phase induction motor runs slower than normal, the more likely defect is
  - (a) improper fuses
  - (b) shorted running winding
  - (c) open starting winding
  - (d) worn bearings.
7. The capacitor in a capacitor-start induction-run ac motor is connected in series with ..... winding.
  - (a) starting
  - (b) running
  - (c) squirrel-cage
  - (d) compensating
8. A permanent-split single-phase capacitor motor does not have
  - (a) centrifugal switch
  - (b) starting winding
  - (c) squirrel-cage rotor
  - (d) high power factor.
9. The starting torque of a capacitor-start induction-run motor is directly related to the angle  $\alpha$  between its two winding currents by the relation
  - (a)  $\cos \alpha$
  - (b)  $\sin \alpha$
  - (c)  $\tan \alpha$
  - (d)  $\sin \alpha/2$ .
10. In a two-value capacitor motor, the capacitor used for running purposes is a/an
  - (a) dry-type ac electrolytic capacitor
  - (b) paper-spaced oil-filled type
  - (c) air-capacitor
  - (d) ceramic type.
11. If the centrifugal switch of a two-value capacitor motor using two capacitors fails to open, then
  - (a) electrolytic capacitor will, in all probability, suffer breakdown
  - (b) motor will not carry the load
  - (c) motor will draw excessively high current
  - (d) motor will not come upto the rated speed.
12. Each of the following statements regarding a shaded-pole motor is true **except**
  - (a) its direction of rotation is from un-shaded to shaded portion of the poles
  - (b) it has very poor efficiency
  - (c) it has very poor p.f.
  - (d) it has high starting torque.
13. Compensating winding is employed in an ac series motor in order to



- (a) compensate for decrease in field flux  
 (b) increase the total torque  
 (c) reduce the sparking at brushes  
 (d) reduce effects of armature reaction.
14. A universal motor is one which  
 (a) is available universally  
 (b) can be marketed internationally  
 (c) can be operated either on dc or ac supply  
 (d) runs at dangerously high speed on no-load.
15. In a single-phase series motor the main purpose of inductively-wound compensating winding is to reduce the  
 (a) reactance emf of commutation  
 (b) rotational emf of commutation  
 (c) transformer emf of commutation  
 (d) none of the above.  
**(Power App.-II, Delhi Univ. Jan. 1987)**
16. A repulsion motor is equipped with  
 (a) a commutator (b) slip-rings  
 (c) a repeller  
 (d) neither (a) nor (b).
17. A repulsion-start induction-run single-phase motor runs as an induction motor only when  
 (a) brushes are shifted to neutral plane  
 (b) short-circuiter is disconnected  
 (c) commutator segments are short-circuited  
 (d) stator winding is reversed.
18. If a dc series motor is operated on ac supply, it will  
 (a) have poor efficiency  
 (b) have poor power factor  
 (c) spark excessively  
 (d) all of the above  
 (e) none of the above.
19. An outstanding feature of a universal motor is its  
 (a) best performance at 50 Hz supply  
 (b) slow speed at all loads  
 (c) excellent performance on dc. supply  
 (d) highest output kW/kg ratio.
20. The direction of rotation of a hysteresis motor is determined by the  
 (a) retentivity of the rotor material  
 (b) amount of hysteresis loss  
 (c) permeability of rotor material  
 (d) position of shaded pole with respect to the main pole.
21. Speed of the universal motor is  
 (a) dependent on frequency of supply  
 (b) proportional to frequency of supply  
 (c) independent of frequency of supply  
 (d) none of the above.  
**(Elect. Machines, A.M.I.E. Sec. B, 1993)**
22. In the shaded pole squirrel cage induction motor the flux in the shaded part always  
 (a) leads the flux in the unshaded pole segment  
 (b) is in phase with the flux in the unshaded pole segment  
 (c) lags the flux in the unshaded pole segment  
 (d) none of the above.  
**(Elect. Machines, A.M.I.E. Sec. B, 1993)**
23. Which of the following motor is an interesting example of beneficially utilizing a phenomenon that is often considered undesirable ?  
 (a) hysteresis motor  
 (b) reluctance motor  
 (c) stepper motor  
 (d) shaded-pole motor.
24. Usually, large motors are more efficient than small ones. The efficiency of the tiny motor used in a wrist watch is approximately..... per cent.  
 (a) 1  
 (b) 10  
 (c) 50  
 (d) 80

## ANSWERS

1. b 2. b 3. d 4. a 5. b 6. d 7. a 8. a 9. b 10. b 11. a 12. d 13. d 14. c 15. d 16. a  
 17. c 18. d 19. d 20. d 21. a 22. c 23. a 24. a

## ROUGH WORK